

Operating Manual
ALTAIR io360 Gas Detector



Order No.: 10184747/01
Print Spec.: 10000005389 (E)
CR 800000040431

 **WARNING!**

Read this manual carefully before using these devices. These devices will perform as intended only if used and maintained in accordance with the manufacturer's instructions. Otherwise, the devices could fail to perform as designed and persons who rely on these devices for their safety could sustain serious personal injury or death.



The Safety Company

1000 Cranberry Woods Drive
Cranberry Township, PA 16066
USA
Phone 1-800-MSA-2222
Fax 1-800-967-0398

MSA Europe GmbH
Schlüsselstrasse 12
8645 Rapperswil-Jona
Switzerland

For your local MSA contacts please go to our website www.MSAafety.com

Contents

1	Safety Regulations	6
1.1	Correct Use	6
1.2	Conformance Statement	6
1.3	FCC Regulations	7
1.4	Safety and Precautionary Measure to be Adopted	8
1.5	Warranty	12
1.6	Exclusive Remedy	12
1.7	Exclusion of Consequential Damage	12
1.8	Liability Information	12
1.9	Magnet disclaimers	12
2	Description	14
2.1	Safety io	14
2.2	Hardware Overview	14
2.3	Detector	15
2.3.1	Internal Features	16
2.4	MSA HUB	18
2.5	ALTAIR io360 Gas Detector Network	19
2.6	Deployment Options	20
3	Hardware Setup	21
3.1	Getting Started	21
3.2	Detector Setup	21
3.3	Powering the Detector	22
3.4	MSA HUB Setup	22
3.5	HUB Assembly	23
3.5.1	Power Requirements	23
3.5.2	Ethernet Cable	24
3.5.3	WiFi	25
3.5.4	HUB LED Description	26
4	Software Configuration Setup	27
4.1	Mobile Device Recommendations	27
4.2	Connecting a Network	27
4.2.1	Detector Profile	28
4.3	Connecting the Detector to the App	28
4.4	Adding a Detector to the Network	28
4.5	Configuring the Detector	29
4.6	Network Settings	29
4.6.1	Names	29
4.6.2	Security	29
4.6.3	Internet Connectivity	28
4.7	Modifying a Network	30
4.7.1	Shared Alarms	30
4.7.2	Evacuation	30
4.7.3	Alarm Settings	30
4.7.4	Detector Special States	31
4.8	Testing the Network	31

5	Deployment	32
5.1	Network Detector Placement	32
5.1.1	Detector	32
5.1.2	Disclaimers	33
5.2	Environmental Considerations	34
5.2.1	SunShield	34
5.2.2	HUB	34
5.2.3	Detector Mounting	35
5.3	Mobile Device Assisted Deployment	36
5.3.1	Network Connectivity	36
6	Operation	37
6.1	Detector	37
6.1.1	Interfaces	37
6.1.2	Button	37
6.1.3	Detector Display Icons	38
6.1.4	Detector LED Definition	39
6.2	Sensor Alarms	40
6.2.1	Sensor Missing Alarm	40
6.2.2	Sensor End of Life Warning	40
6.2.3	Sensor End of Life Indicator	40
6.2.4	Exceed High and Low of Sensor	41
6.3	Monitoring Oxygen Concentration	41
6.4	Monitoring Combustible Gases	41
6.5	Environmental Factors	42
6.5.1	Pressure Changes	42
6.5.2	Humidity Changes	42
6.5.3	Temperature Changes	42
6.6	Data	43
6.6.1	Data Log	43
6.7	HUB	44
6.7.1	Factory Reset	44
7	Calibration and Bump	46
7.1	Bump Test	46
7.1.1	Bump Test Frequency	46
7.1.2	Equipment	47
7.2	Performing a Bump Test	47
7.2.1	Calibration	50
8	Maintenance and Service	55
8.1	Tools Required	55
8.2	Authorized Maintenance	55
8.3	Detector	56
8.3.1	Routine Cleaning for Detector	56
8.3.2	Routine Cleaning of Dust Build up on the Magnet	56
8.4	Dust and Dirt Exposure	56
8.5	Chemical Exposure	56
8.6	Water Exposure	56
8.7	Routine Cleaning for Detector Accessories	56

8.8	Batteries	.57
8.9	Gasket Replacement	.60
8.10	Sensors	.63
8.11	Sensor Maintenance	.63
8.12	Sensor Configurations	.63
8.13	Replacing Sensors	.64
8.14	Horn Replacement	.67
8.15	Storage	.70
8.16	HUB	.70
8.16.1	Cleaning the HUB	.70
9	Decommissioning	.71
9.1	Detector	.71
9.1.1	Powering Down	.71
9.1.2	Removing Individual Detectors from a Network	.71
9.1.3	Reset Network Features	.71
9.1.4	Factory Reset	.71
9.1.5	Storage Conditions	.71
9.2	HUB	.72
9.2.1	Storage Conditions	.73
10	Troubleshooting	.74
10.1	Detector	.74
11	Technical Data	.75
11.1	Detector	.75
11.2	MSA HUB	.76
11.3	Factory Set Alarm Thresholds and Set Points	.77
11.3.1	Calibration Gas Defaults	.77
11.4	Gas Performance Specification	.78
11.4.1	Combustible Gas	.78
11.4.2	Oxygen	.78
11.4.3	Carbon Monoxide	.78
11.4.4	Carbon Monoxide Cross Sensitivity	.79
11.4.5	Hydrogen Sulfide	.79
12	Patents	.80
13	Ordering Information	.81
13.1	Detector Spare Parts and Accessories	.81
13.2	MSA HUB Spare Parts	.81
13.3	Calibration	.82



1 Safety Regulations

1.1 Correct Use

The detector(s) and HUB(s) are for use by trained and qualified personnel. The detector is designed to detect exposure of a worksite to select combustible and select toxic gases and vapors as well as low level of oxygen - details provided in section 11 "Technical Data".

It is imperative that this operating manual be read and observed when using the detector(s) and HUB(s). In particular, the safety instructions, as well as the information for the use and operation of the detector(s) and HUB(s), must be carefully read and observed. Furthermore, the national regulations applicable in the user's country must be taken into account for a safe use.

The detector can be equipped to detect oxygen for monitoring inertization applications.

NOTE: While the detector can detect up to 30% oxygen in ambient air, it is approved for use only up to 21% oxygen.

WARNING!

- The ALTAIR io360 Gas Detector is not a substitute for wearing a personal gas detector. Personal gas detectors must be worn at all times by all personnel in a potentially hazardous location.
- If the detector is subjected to physical shock, the detector must pass calibration before continuing use.
- Use only to detect gases/vapors for which a sensor is installed.
- Do not use to detect combustible dusts or mists.
- For accurate catalytic combustible readings, make sure adequate oxygen is present ($> 10\% O_2$).
- Risk of Explosion: Do not remove or replace batteries in a hazardous location.
- Do not alter or modify the detector or HUB.
- Before using the product, operation must be verified. The product must not be used if:
 - it is damaged,
 - a competent servicing/maintenance has not been made,
 - genuine MSA spare parts have not been used.
- Do not use the detector for prolonged periods in an atmosphere containing a concentration of fuel or solvent vapors that may be greater than 10% LEL.
- Inappropriate use, maintenance or servicing may affect the ability of the detector to perform its intended functions.
- Do not open the detector or HUB when an explosive atmosphere is present.

Failure to follow these warnings can result in serious injury or death.

Alternative use, or use outside this specification will be considered as non-compliance. This also applies especially to unauthorized alterations to the product and to commissioning work that has not been carried out by MSA or authorized persons.

1.2 Conformance Statement

MSA certifies that the materials, components, and/or instruments delivered in this shipment conform to all applicable specifications. The items delivered have been processed through the appropriate approved document controlled procedures for receiving, manufacturing and inspection. The materials, components, and/or instruments were inspected, tested, and calibrated, as applicable, per the associated drawings, standards requirements, and/or specifications, and were deemed acceptable by appropriate authorized personnel.

1.3 FCC Regulations

United States

This equipment has been tested and found to comply with the limits for a Class B digital device, pursuant to Part 15 of the FCC Rules. These limits are designed to provide reasonable protection against harmful interference in a residential installation. This equipment generates uses and can radiate radio frequency energy and, if not installed and used in accordance with the instructions, may cause harmful interference to radio communications. However, there is no guarantee that interference will not occur in a particular installation. If this equipment does cause harmful interference to radio or television reception, which can be determined by turning the equipment off and on, the user is encouraged to try to correct the interference by one or more of the following measures:

- Reorient or relocate the receiving antenna.
- Increase the separation between the equipment and receiver.
- connect the equipment into an outlet on a circuit different from that to which the receiver is connected.
- Consult the dealer or an experienced radio/TV technician for help.



This equipment generates or uses RF energy. Changes or modifications to this equipment is strictly prohibited, and may cause harmful interference. The user could lose the authority to operate this equipment if an unauthorized change or modification is made.

This equipment complies with FCC radiation exposure limits set forth for an uncontrolled environment. End users must follow the specific operating instructions for satisfying RF exposure compliance. This transmitter meets both portable and mobile limits as demonstrated in the RF Exposure Analysis. This transmitter must not be co-located or operating in conjunction with another antenna or transmitter except in accordance with FCC multi-transmitter product procedures.

- The antenna(s) must be installed such that a minimum separation distance of 20 cm is maintained between the radiator (antenna) and all persons at all times.

Canada

This device contains License-exempt transmitter(s)/receiver(s) that comply with Innovation, Science and Economic Development Canada's License-exempt RSS(s).



Operation is subject to the following two conditions:

- 1) This device may not cause interference.
- 2) This device must accept any interference, including interference that may cause undesired operation of the device.



WARNING!

This is a Class B product in accordance with CISPR 22. In a domestic environment, this product may cause radio interference, in which case the user may be required to take adequate measures. Failure to follow this warning can result in serious personal injury or death.

This Class B digital apparatus complies with Canadian ICES-003.

WARNING!

This device complies with Part 15 of the FCC Rules.

Operation is subject to the following two conditions:

- 1) This detector may not cause harmful interference.
- 2) This detector must accept any interference received, including interference that may cause undesired operation.

Failure to follow this warning can result in serious personal injury or death.

WARNING!

L'émetteur/récepteur exempt de licence contenu dans le présent appareil est conforme aux CNR d'innovation, Sciences et Développement économique Canada applicables aux appareils radio exempts de licence.

L'exploitation est autorisée aux deux conditions suivantes:

- 1) l'appareil ne doit pas produire de brouillage, et
 - 2) l'utilisateur de l'appareil doit accepter tout brouillage radio électrique subi même si le brouillage est susceptible d'en compromettre le fonctionnement.
-

1.4 Safety and Precautionary Measure to be Adopted

WARNING!

All detector readings and information must be interpreted by someone trained and qualified in interpreting detector readings in relation to the specific environment, industrial practice and exposure limitations.

Failure to follow this warning can result in serious personal injury or death.

Wireless Operation

WARNING!

Wireless Operation is dependent upon signal availability of the wireless service(s) necessary to maintain the communication link. Loss of wireless signal will prevent communication of alarms and other information to linked devices. Take appropriate precautions in the event a loss of wireless signal occurs.

Failure to follow this warning can result in serious personal injury or death.

Bluetooth Operation

Bluetooth Operation is dependent upon signal availability of the wireless service(s) necessary to maintain the communication link. Loss of wireless signal will prevent communication of alarms and other information to linked devices. Take appropriate precautions in the event a loss of wireless signal occurs.

Bump Test Frequency

Bump test frequency may be stipulated by national regulations. In the absence of national standards, corporate regulations must stipulate bump test frequency. Bump testing must be conducted at a minimum before each deployment of a device.

When use conditions permit, bump testing should be performed daily.

If tested, the device must pass the bump test. If it fails the test, perform a calibration before using the device.

A bump test must be performed more frequently than daily if any of the following occur:

- The device is subjected to high levels of contaminants.
- The device is subjected to rain or water spray.
- The tested atmosphere contains the following materials, which may desensitize the combustible gas sensor and reduce its readings:
 - Organic silicones
 - Silicates
 - Lead-containing compounds
 - Hydrogen sulfide exposures over 200 ppm or exposures over 50 ppm for one minute
 - Rain
- The SensorShield is not installed.
- The device is exposed to conditions that could lead to blockage of the sensor path (including but not limited to snow and ice storms, icing conditions, rain or water spray, dusty or dirty environments).

CSA requires (per 22.2 NO. 152) that combustible sensor sensitivity be tested before each day's use on a known concentration of methane equivalent to 25 to 50 % of full scale concentration. ACCURACY MUST BE WITHIN 0 to +20 % OF ACTUAL. Correct accuracy by performing the calibration procedure described in section 7.2.1 "Calibration".

Check Minimum Concentration of a Combustible Gas

The minimum concentration of a combustible gas in air that can ignite is defined as the Lower Explosive Limit (LEL). A combustible gas reading of "XXX" or "+++" indicates the atmosphere is above 100 % LEL or 5.00 % vol CH₄, and an explosion hazard exists. Move away from hazardous area immediately.

Observe Atmosphere

Do not use the detector(s) to test for combustible or toxic gases in the following atmospheres as this may result in erroneous readings:

- Oxygen-deficient or oxygen-rich atmospheres
- Reducing atmospheres
- Furnace stacks
- Inert environments
- Atmospheres containing combustible airborne mists/dusts.

Use the detector(s) only to detect gases/vapors for which a sensor is installed.

Make sure greater than 10% oxygen is present for accurate combustible readings with the catalytic sensor.

Not to be used for gases having a flash point in excess of 38°C (100°F)

Do not use the detector(s) to test for combustible gases in atmospheres containing vapors from liquids with a high flash point (above 38°C, 100°F), as this may result in erroneously low readings.

Physical Shock

If the detector is subject to physical shock, the detector must pass calibration before continuing use, e.g. from the dropping the detector.

Sensor Maintenance

Do not block sensor openings as this may cause inaccurate readings. Do not press on the face of the sensors, as this may damage them and cause erroneous readings. Do not use compressed air to clean the sensor holes, as the pressure may damage the sensors.

Safety Regulations

Observe Proper Time for Display Stabilizing

Allow sufficient time for detector to display accurate reading. Response times vary based on the type of sensor being utilized.

Observe Proper Battery Maintenance

WARNING!

Follow all instructions related to use and handling of batteries. Improper use and handling can result in battery leakage, battery venting, explosion or fire.

- Use only batteries with MSA Part number 10201430 (Tadiran model number TL-5920 and Tadiran model SL-2770)
- Do not mix batteries of different charge levels.
- When replacing batteries of a detector, do not mix old and new batteries.
- Replace all batteries of a detector when needed.
- Do not mix battery lots - check battery label for lot information.
- If not using all new batteries, only use the battery set that was previously partially discharged in the same instrument.
- Battery replacement is to be performed only by a person that is trained to service and repair the product.

Failure to follow these warnings can result in serious personal injury or death.

WARNING!

DO NOT OPEN THE DETECTOR OR HUB WHEN AN EXPLOSIVE ATMOSPHERE IS PRESENT.
Failure to follow this warning can result in serious personal injury or death.

The battery shall not be replaced in a hazardous area. Only use Tadiran model number TL-5920 and Tadiran model SL-2770, MSA Part Number 10201430.

Observe the following when using and handling the batteries:

- Do not insert batteries in reverse. Observe the + and - markings on the battery and on the device.
- Do not short circuit the batteries.
- Do not charge the batteries.
- Do not force discharge the batteries.
- Do not leave discharged batteries in the device.
- Do not overheat the batteries.
- Do not open the batteries.
- Do not deform the batteries.
- Do not expose the batteries to water.
- Do not encapsulate and/or modify the batteries.
- Store batteries in their original packaging away from metal objects. If already unpacked, do not mix or jumble batteries.

US

Be Aware of Environmental Conditions

A number of environmental factors may affect the sensor readings, including changes in pressure, humidity and temperature. Pressure and humidity changes also affect the amount of oxygen actually present in the atmosphere.

Detector(s) exposed to environmental conditions must have a SensorShield installed.

 WARNING!

A SensorShield must be installed on detector(s) in all situations where the detector(s) may be subject to conditions that could lead to blockage of the sensor path (including, but not limited to, rain, water spray, dusty or dirty environments, snow and ice storms or icing conditions). Failure to do so may result in erroneous gas readings or inability to detect a gas event.

Failure to follow this warning can result in serious personal injury or death.

Be Aware of the Procedures for Handling Electrostatically Sensitive Electronics** WARNING!**

The detector contains electrostatically sensitive components. Do not open or repair the detector without using appropriate electrostatic discharge (ESD) protection. Electrostatic discharge can damage sensitive components and result in erroneous gas readings or inability to detect a gas event.

Failure to follow this warning can result in serious personal injury or death.

The warranty does not cover damage caused by electrostatic discharges.

Be Aware of the Product Regulations

Follow all relevant national regulations applicable in the country of use.

Special Conditions for Safe Usage - Detector

In the event of combustible sensor overrange, the detector will enter a Lock Alarm state, which must be reset in a fresh air environment. To reset this alarm, cycle power off and on, in fresh air. Keep the detector in the fresh air environment until LEL or CH₄ readings have stabilized and then follow the Calibration instructions contained in this manual. Before placing a detector back into service, it must be pass calibration after entering a locked alarm state.

The RF radiation power used to activate the RFID tag antenna shall not exceed 2 Watts for EPL Group IIC applications.

Special Conditions for Safe Usage - HUB

For extended lifespan of the device, it should be installed protected from strong ultraviolet light exposures. The device shall be installed and maintained such that the risk of electrostatic discharge is minimized by applying appropriate means. The device shall be installed in upright position in accordance with the instructions. The device shall only be used in an area polluted less than pollution degree 2, as defined in IEC 60664-1. The device shall be protected against an impact energy in excess of 4J on the power supply plug and connector.

Be Aware of the Warranty Regulations

The warranties made by MSA The Safety Company with respect to the product are voided if the product is not used and maintained in accordance with the instructions in this manual. Please protect yourself and others by following them. We encourage our customers to write or call regarding this equipment prior to use or for any additional information relative to use or service.

1.5 Warranty

Item	Warranty
Chassis and electronics	Four years
All sensors unless otherwise specified	Four years
Low energy combustible Sensor	One year
Oxygen Sensor	Two years
HUB	Four years

This warranty does not cover filters, fuses, batteries, etc. Certain other accessories not specifically listed here may have different warranty periods. This warranty is valid only if the product is maintained and used in accordance with Seller's instructions and/or recommendations.

The Seller shall be released from all obligations under this warranty in the event repairs or modifications are made by persons other than its own or authorized service personnel or if the warranty claim results from physical abuse or misuse of the product. No agent, employee or representative of the Seller has any authority to bind the Seller to any affirmation, representation or warranty concerning this product. Seller makes no warranty concerning components or accessories not manufactured by the Seller, but will pass on to the Purchaser all warranties of manufacturers of such components.

THIS WARRANTY IS IN LIEU OF ALL OTHER WARRANTIES, EXPRESSED, IMPLIED OR STATUTORY, AND IS STRICTLY LIMITED TO THE TERMS HEREOF. SELLER SPECIFICALLY DISCLAIMS ANY WARRANTY OF MERCHANTABILITY OR OF FITNESS FOR A PARTICULAR PURPOSE.

1.6 Exclusive Remedy

It is expressly agreed that Purchaser's sole and exclusive remedy for breach of the above warranty, for any tortious conduct of Seller, or for any other cause of action, shall be the replacement at Seller's option, of any equipment or parts thereof, which after examination by Seller is proven to be defective. Replacement equipment and/or parts will be provided at no cost to Purchaser, F.O.B. Seller's Plant. Failure of Seller to successfully replace any nonconforming equipment or parts shall not cause the remedy established hereby to fail of its essential purpose.

1.7 Exclusion of Consequential Damage

Purchaser specifically understands and agrees that under no circumstances will seller be liable to purchaser for economic, special, incidental or consequential damages or losses of any kind whatsoever, including but not limited to, loss of anticipated profits and any other loss caused by reason of non-operation of the goods. This exclusion is applicable to claims for breach of warranty, tortious conduct or any other cause of action against seller.

1.8 Liability Information

MSA accepts no liability in cases where the detector and/or HUB has been used inappropriately or not as intended.

The selection and use of the detector and/or HUB must be under the direction of a qualified safety professional who has carefully evaluated the specific hazards of the jobsite where it will be used and who is completely familiar with the product and its limitations. The selection and use of the detector and/or HUB and its incorporation into the safety scheme of the jobsite is the exclusive responsibility of the employer.

Changes and modifications not expressly approved by the manufacturer will void the user's authority to operate the detector and/or HUB.

1.9 Magnet disclaimers

The detector contains a Neodymium magnet for mounting. MSA recommends the following:.

Keep magnets away from

- electronic devices
- storage devices
- identification cards
- credit cards



WARNING!

Magnets can have an adverse effect on medical devices such as pacemakers, implantable cardio defibrillators (ICD) and other implantable medical devices. Persons with such devices should maintain sufficient distance between the medical device and the magnet. Please consult your physician or pacemaker or ICD manufacturer for additional guidance and recommendations.

Neodymium magnets have a strong attractive force. Each can attract quickly when in close proximity to another. Individual magnets can attract quickly when in close proximity to metal objects.

Use protective gloves and eyewear and keep hands away from the back of the detector where the magnet is housed when handling the detector to avoid a potentially severe pinch injury.

Failure to follow this warning can result in serious personal injury or death.

2 Description

2.1 Safety io

Safety io, LLC (a subsidiary of MSA The Safety Company) developed the Grid industrial safety software platform so that, among other things, ALTAIR io360 users can proactively and easily manage and monitor their detectors as well as their associated networks and data logs.

For more information, visit <http://www.safetyio.com>.

2.2 Hardware Overview

One to four detector(s) contained per box depending on the total number of detectors ordered with:

- Three batteries pre-installed per detector with a pull tab. Battery pull tab must be removed before use
- One SensorShield pre-installed per detector
- One Calibration Cap per box
- One set of calibration tubing per box
- Quick start guide
- Addendum manual

One MSA HUB per box with:

- Power supply
- Region specific AC power cord
- DC Cord
- Antenna
- Quick start guide



2.3 Detector

The ALTAIR io360 Gas Detector will be referred to as the detector throughout the manual. The detector is an area monitor suitable for indoor or outdoor use, to monitor toxic and combustible gases, and oxygen levels of a work site. A variety of applications include fence lines and perimeters, confined spaces, and targeted areas where leaks could occur. Up to four gases, via three sensors can be monitored (one Two-Tox Sensor can detect two toxic gases with a single sensor). The alarm levels for the individual gases are factory-set and can be changed with the Safety io Grid mobile app, which will be referred to as the app throughout the manual. The detector, as a standalone gas detector can alarm audibly and visually when alarm levels are exceeded. Data logs are stored on the detector, which can be downloaded when convenient via the app. An overview of features are provided in the images and tables below:



Fig. 1 Gas Detector Front

- | | |
|---|------------------------------------|
| 1 | LED light ring |
| 2 | Display |
| 3 | Combustible sensor inlet |
| 4 | Low power combustible sensor inlet |
| 5 | Screws (6) |
| 6 | Toxic sensor inlet |
| 7 | Oxygen sensor inlet |
| 8 | Horn |
| 9 | Button and RFID read zone |

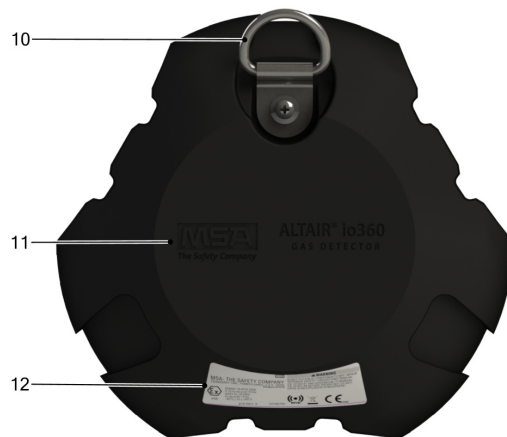

Fig. 2 Gas Detector Back

- | | |
|----|-----------------|
| 10 | D-Ring |
| 11 | Magnet |
| 12 | Approvals label |

Description

2.3.1 Internal Features

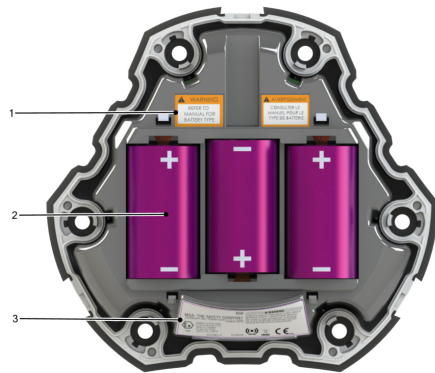

Fig. 3 Batteries

- 1 Battery type warning
- 2 Batteries

- 3 Approvals label

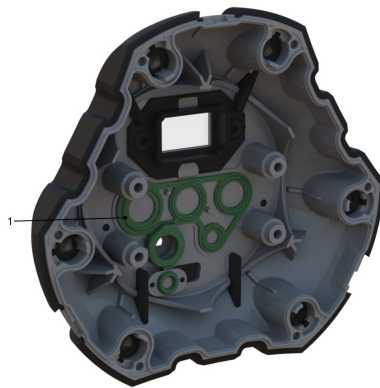

Fig. 4 Sensor Gasket

- 1 Sensor gasket

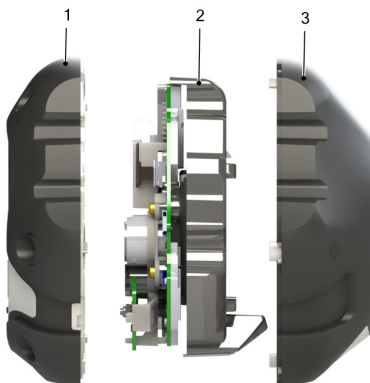

Fig. 5 Housing

- 1 Front housing
- 2 Battery holder

- 3 Back housing

US

Feature	Description
Sensors	Detect gas levels which trigger alarm if applicable.
Horn	The horn provides an audible alarm of 90 dB at 30 cm.
LED Light Ring	Communicate detector operations e.g. alarm, maintenance, connectivity status, calibration, etc.
Display	Displays gas reading, connectivity status, operation instructions, sensor health.
Button	Various set up and operational functions. See section 6 "Operation".
D-Ring	Attachment point for hanging the detector.
Magnet	Mount detector via magnet.
Batteries	Power the detector.
RFID Reader	Reads RFID chip in the calibration cap that initiates Bump or Calibration.

Description

2.4 MSA HUB

The MSA HUB will be referred to as the HUB throughout the manual. The HUB is an industrial gateway that enables mesh connectivity with ALTAIR io360 Gas Detectors. It acts as a gateway to Safety io Grid and/or mobile devices for monitoring and management.



Fig. 6 MSA HUB

- | | | | |
|---|------------------------------------|---|--------------------------------|
| 1 | Local radio antenna (mesh network) | 5 | Mounting brackets |
| 2 | Wifi/Bluetooth antenna | 6 | Ethernet connection (optional) |
| 3 | Housing | 7 | Power connector |
| 4 | Status LEDs | 8 | Grounding terminal |

Features

Feature	Description
Compact Housing	Protective housing from environmental conditions for the HUB.
Wifi and Bluetooth Antenna	Network monitoring options with or without internet connectivity
Ethernet Connection	M12-4 Pin connector type ethernet connection at 10/100 Mbps
Power Connection	Supplies 24V power to the HUB with MSA supplied power adapter.
LED Status Lights	Indicate HUB's status . See section 3.5.4 "HUB LED Description".

2.5 ALTAIR io360 Gas Detector Network

The detectors and HUB form a wireless mesh network. Detectors on this mesh network have the ability to utilize shared alarms. Shared alarms are when the detectors on the network enter an evacuation state if another detector enters an alarming state.

Additionally, the HUB acts as a gateway which gives authorized users the ability to:

- monitor the gas readings and the network life and health
- send manual evacuations
- other network management functions

The network can be monitored locally or remotely. Local access is via an iOS or Android mobile device when securely connected to the HUB via Bluetooth. Remote access is granted to Safety io Grid subscribers who have connected their MSA HUB to the internet using Wi-Fi and/or ethernet connectivity. Safety io Grid remote monitoring can take place on a computer where Fleet Manager and Live Monitoring can be utilized in addition to being able to remotely use the app to manage the network(s).

The maximum network size are defined as follows*:

- Up to 32 detectors and a HUB with 915 MHz radio
- Up to 16 detectors and a HUB with 868 MHz radio

Unlimited standalone detectors can be deployed on site without being connected to a network.

* Local regulations define which frequency must be utilized.

2.6 Deployment Options

A key feature of the ALTAIR io360 gas detection solution is the easy and intuitive setup and deployment. Throughout this manual, the word "setup" will refer to workflows and tasks associated with preparing detectors and HUB(s) to function as necessary for individual needs. The word "deploy" or "deployment" will refer to the process of placing ALTAIR io360 Gas Detectors and MSA HUB(s) on the worksite, entering an operational state and to begin monitoring an area.

Detectors can be ordered preconfigured from MSA, ready to use. However, the app is required to modify the configuration of the detector, setup the detector(s) and the HUB(s) as a network, and access data logs. The app guides the user through editing detector configurations, HUB configurations, managing networks, and the connecting the HUB to the internet and Safety io Grid.

To deploy the detectors and HUBs in the field, the app enhances the experience, particularly when assigning locations to detectors to view within the Safety io Grid. However, a mobile device is not required to deploy in the field.

The detector has three deployment options: standalone detectors; detectors and HUB; detectors, HUB, and remote monitoring via the Grid. The differences between the deployment options are detailed in the table below:

	Standalone Detector(s)	Detectors and HUB	Detectors, HUB, and Remote monitoring via the Grid
Mobile-guided setup	x	x	x
Simultaneously Configure Multiple Detectors		x	x
Gas Alarm	At the detector	At the detector and on the app	At the detector and on the Grid
Data logs	Use app to download	Use app to download	Saved on the Grid
Live Monitoring & Updates		On premises	Anywhere
Manually Trigger Evacuation Alert		On premises	Anywhere

US

3 Hardware Setup

3.1 Getting Started



Setup must be performed in a fresh air environment to ensure proper function.

For ease and convenience, consider having the following:

- HUB(s)
- Detector(s) with SensorShield(s)
- Workspace with power source for the HUB
- If planning to use the Safety io Grid, internet connectivity such as:
 - Wifi credentials
 - Functioning ethernet port
- Mobile device with app installed and Bluetooth enabled
- Calibration gas and accessories, see section 7.2.1 "Calibration"
- #1 Phillips screwdriver
- Slotted screwdriver
- 5 mm hex key
- T20 Torx driver

3.2 Detector Setup

If the detector is being set up for the first time, the battery tab will have to be removed before continuing the remaining set up.

(1) Remove pull tab.

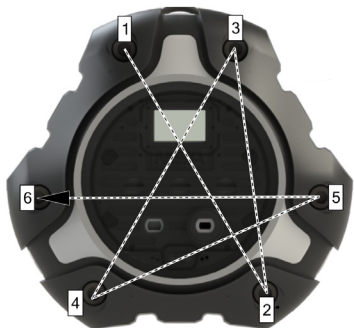

(2) Finish tightening screws in the pattern as shown.
Tighten screws to a torque of 10 in-lb +/- 1 in-lb (1.1 Nm +/- 0.1 Nm).



If batteries are removed or pull tab has been inserted for an extended period of time, allow time for sensor warm up before use. Detector may briefly enter an alarm state while sensors are warming up.

3.3 Powering the Detector



- (1) Hold detector button for approximately 3 seconds.
- (2) Release button.

3.4 MSA HUB Setup

The HUB must be disconnected from the power supply prior to assembly. The power supply may be activated only after the HUB is fully assembled and connected. Connection or disconnection of energized non-intrinsically-safe circuits is only permitted in the absence of a hazardous atmosphere.

WARNING!

- Do not connect or disconnect power and/or Ethernet connections to or from the HUB in a hazardous location. Connect or disconnect only in a non-hazardous area.
- Do not connect or disconnect Ethernet connection when the power supply is energized.
- The HUB must be disconnected from the power supply prior to assembly.
- Do not remove, replace or disconnect the HUB while the circuit is live.
- Do not open the HUB when the power supply is energized.
- Do not open the HUB in a hazardous location.
- Do not substitute components. Substitution of components may impair intrinsic safety.

Failure to follow these warnings can expose a user to risk of electrical shock or ignition of explosive atmospheres and can result in serious personal injury or death.

WARNING!

- Do not assemble or operate damaged components.
- Do not use if the HUB is damaged, a competent servicing/maintenance has not been made or genuine MSA spare parts have not been used.

Failure to follow this warning can result in serious personal injury or death.



The HUB contains electrostatically sensitive components. Observe precautionary measures against electrostatic discharge during assembly.

To ensure the ingress protection rating IP67:

- all seals must be undamaged and correctly fitted
- all screws of the housing / housing cover must be tightened with a torque of 13 in-lb +/- 1 in-lb (1.5 Nm +/- 0.1 Nm)
- only use MSA supplied cables
- all connectors must be hand tightened
- If the ethernet connection is not in use, it must be sealed with MSA supplied blind plug.

IP ratings do not imply that the equipment will detect gas during and after exposure to these conditions.

3.5 HUB Assembly

Only perform assembly with the HUB powered off.

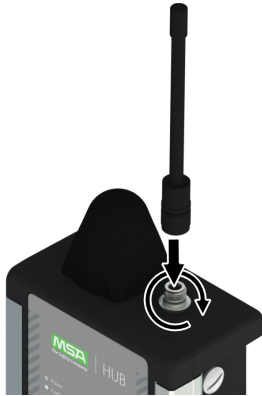

(1) Hand-screw antenna.

WARNING!

- Do not install in hazardous location.
- Do not install with the HUB energized.
- Do not touch the circuit board assembly.
- Observe electrostatic procedures.

Failure to follow these warnings can result in serious personal injury or death.

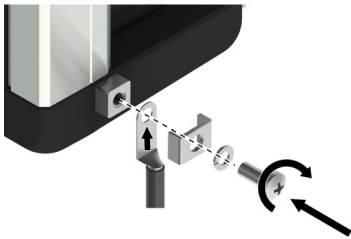

- (2) Install grounding Clamp. Wire cross section for grounding clamp must be $\geq 0.5\text{mm}^2$
- Remove grounding clamp.
 - Insert grounding cable and re-tighten grounding clamp with a torque of 17 in-lb +/- 1 in-lb (2 Nm +/- 0.1 Nm).

WARNING!

The HUB must be stationary and may be installed on a desk or bench or mounted to a wall while in use. Follow mounting instructions in the HUB Instruction Manual or damage may occur. Using the product as a portable device can result in damage that prevents proper operation. Failure to follow this warning can result in serious personal injury or death.

3.5.1 Power Requirements

Input power requirements: 100 - 240 VAC, 47 - 63 Hz
(Several different prong types are available for world-wide AC sockets)

3.5.2 Ethernet Cable

Ethernet cable is optional and not included.

WARNING!

Ensure the HUB is not energized.

Perform only in a non-hazardous environment.

Failure to follow these warnings can result in serious personal injury or death.



- (1) Unscrew the Ethernet blind plug with a slotted screwdriver.



- (2) Open housing by opening the joints and removing the two lid screws as shown.

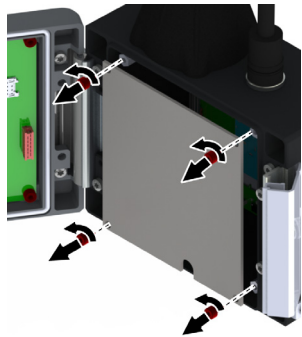

- (3) Remove the cover panel by removing the four screws as shown.



- (4) Unscrew the two screws to remove the mounting flange, using a Phillips #2 screw driver.

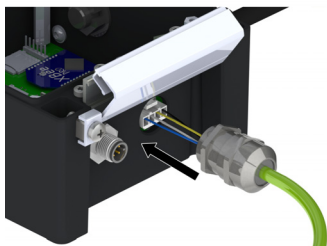

- (5) Insert the Ethernet plug through the hole.

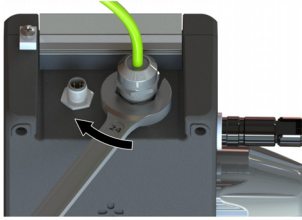

- (6) Tighten the inner nut to a torque of 66 in-lb +/- 3 in-lb (7.5 Nm +/- 0.3 Nm) using 24 mm wrench.



- (7) Connect the Ethernet connector to the main board.



- (8) Tighten the outer nut to a torque of 3.5 in-lb +/- 1 in-lb (0.4 Nm +/- 0.1 Nm) to seal the cable gland.



- (9) Fasten the two screws to install the mounting flange to the housing.

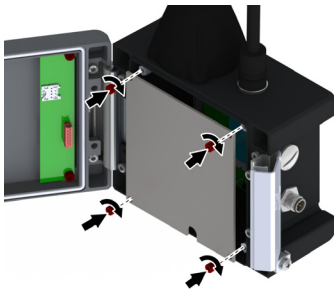

- (10) Install the cover panel. Torque screws to 3.5 in-lbs +/- 1 in-lb (0.4 Nm +/- 0.1 Nm).



- (11) Torque the screws to 13 in-lb +/- 1 in-lb (1.5 Nm +/- 0.1 Nm).

- (12) Close the housing lid.
The HUB is assembled.







3.5.3 WiFi

The MSA HUB supports only WPA2 personal networks.

3.5.4 HUB LED Description



Fig. 7 MSA HUB LEDs

Pattern	Name	Status	Description
	Power	On/Off	On - HUB is on.
	Configuration	On/Off	On - Mobile device is connected to the HUB via Bluetooth.
	Network Connection	Blinking	HUB is connected to Internet.
	Network Connection	On/Off	On - Connection to Safety io Grid is established.
	MSA Radio Connection	On/Off	On - Mesh radio is on.
	Error Case	Blinking simultaneously	Any module is in error state.
	Update Process	Flashing sequentially	The HUB is loading and installing a software update.

4 Software Configuration Setup

This section details the software configuration setup steps.

If using pre-configured kits, skip the steps in this section.

4.1 Mobile Device Recommendations

The mobile device must have Bluetooth capability and Android 5.0 or Apple iOS 8 or newer operating systems.

The app can be downloaded and installed from the Google Play store or the App Store.

4.2 Connecting a Network

Connecting via Bluetooth enables communication with detector(s) and the HUB(s). The detector(s) and/or HUB(s) mobile device will need to be connected. This requires both devices to be in Bluetooth range of the mobile device. The app will guide this process.

Network connection overview:

- App connects to the HUB
- App connects to detector(s)
- Detector(s) connect to the HUB

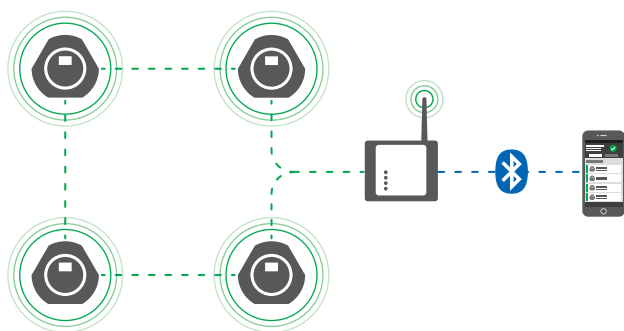

Fig. 8 Network Connection Overview

If a preconfigured kit, typically sold as 4, 8, 16, 32 packs has been purchased, the detectors and HUB will arrive connected to each other.

To connect a network:

- (1) Start the app.
- (2) If not using the Grid, choose “Skip“.

or

Log into the Grid.

The Networks dashboard displays all HUBs in Bluetooth connectivity range of the mobile device.

If connected to the Safety io Grid, all HUBs on the Grid account are displayed as well.

- (3) From the Network dashboard screen, start your network setup journey.

The app will search for HUB(s) available to create a network.

The app will confirm connectivity with the HUB with a green checkmark.

The app will ask to connect your HUB to the internet if using safety io Grid. If using the Grid, the app will guide you through registering your HUB to your account.

Optional:

- (4) Select HUB connectivity.
- (5) Name the network associated with the HUB.

4.2.1 Detector Profile

If using the factory detector profile, skip this section.

Editing the detector profile is optional. See section 11 "Technical Data" for Detector profile specifications.

4.3 Connecting the Detector to the App

- (1) Press the detector button to ensure that Bluetooth is communicating.
- (2) Within the app, search for the detector.
- (3) Within the app, select detector to be connected.
- (4) When prompted, acknowledge connection on detector.
 - a) Press the button.

4.4 Adding a Detector to the Network

- (1) Press the detector button to ensure that the Bluetooth is communicating.

The top LED will be blinking purple for detectors not connected to a network..

Bluetooth will communicate for approximately 5 minutes after pressing the detector button.

The app will show all detectors communicating Bluetooth in range of the mobile device.
- (2) From this app screen, select the detector(s) to be added to the network.

NOTE: For optimal Bluetooth performance, do not add more than 8 detectors to a network at a time.
- (3) Press "Save".

The app updates the list of detector(s) not connected until all detectors have been added to the network.

The yellow LED indicates the network addition is being processed.

Each detector will sequentially prompt you to accept the network configuration.
- (4) Press the detector button to complete the network configuration.

It takes approximately 2 minutes for detector connection to be completed.

Once the connection is established, the network connectivity icon will appear on the detector's display and the detector LED will blink green.
- (5) Follow the app instructions to exit the workflow.
- (6) Repeat these steps until all desired detectors are added to the network.

4.5 Configuring the Detector

- (1) With the detector(s) connected to the app, follow the app prompts.
- (2) Through the app dashboard, search for nearby detectors to start the configuration process.
The app starts a process to setup a detector profile, which can be used on any detector that is accessed by the app.

The following parameters can be configured:

- Latching vs. non-latching alarms
- Enable/disable sensor channels
- Configure alarm set points
- Enable and disable high and low alarms
- Mesh radio enable
- Evacuation enable/disable
- Horn enable/disable
- LED enable/disable
- Frontlight enable/disable
- Calibration due enable/disable
- Calibration interval days
- Passcode
- Company name
- Department name

4.6 Network Settings

4.6.1 Names

The user can name the devices to help identify detectors, HUBs, and networks.

Follow the app prompts to rename items.



HUBs have a unique name which is "HUB" plus the last seven digits of the serial number.

Detectors have a unique name in the format of "io360 XXXX" with characters 0-9 and A-Z.
The user can change the detector and HUB names through the app.

4.6.2 Security

The user can create and require a security code for a network. MSA recommends a security code to prevent modifying the settings on the network, protect configuration settings, and prevent downloading logs.

Each detector is allowed to have a unique security code, if desired (users will be warned that detector has different security code). If using the Safety io Grid, the user can sync the security code from the Grid.

Entering the Security Code:

- (1) In the app, browse to the PIN settings.
- (2) Enter the security code.
 - a) Remember the security code for future use.

The HUB and all detectors on the network receive the same security code.

The security code can be changed in the app.

4.6.3 Internet Connectivity

The HUB can be connected to the internet for Grid connectivity with Ethernet and/or Wifi.

IF the HUB is configured to connect via both ethernet and Wifi, ethernet will be the primary method of connectivity and Wifi will be the backup.

4.7 Modifying a Network

Connect the app to the HUB to:

- Add detector(s) to network: max. 32 for 915 Mhz and 16 for 868 Mhz
- Remove detector(s) from network
- Edit network name
- Enable/disable shared alarms

4.7.1 Shared Alarms

A shared alarm is an alarm that, from the alarm source through the network, reaches every device on the same network.

Shared alarms latch and non-latch based on your alarm settings.

There are two types of shared alarms:

- Network triggered shared alarm
- Manually initiated shared alarm

4.7.2 Evacuation

An evacuation alarm can be initiated manually and communicated through the network at the discretion of an authorized user.

Alarms are configured as shared alarms by default.

The user can define evacuation alarms to not be shared through the network.

4.7.3 Alarm Settings

Factory default alarm set points are stated in the table below and can be changed within the stated limits.

Use the app to change the alarm settings.

Sensor	Unit of Measure	Low Alarm Default	High Alarm Default	Min Low Alarm	Max High Alarm
Combustible	% LEL	10	20	5	60
Combustible	% Vol	0.50	1.00	0.25	3.00
CO	PPM	25	100	7	1700
H ₂ S	PPM	10	15	5	175
O ₂	% Vol	19.5	23.0	5.0	24.0

Latching Alarm Configurations

A latching alarm persists until acknowledged by the user, even if the gas reading returns to non-alarm levels.

The factory default settings for alarms are set to non-latching.

Alarm latching behavior can be configured for each alarm type in the app.

4.7.4 Detector Special States

During detector configuration changes, the detector will temporarily enter a special state.

If LEDs are enabled, the LEDs will indicate the special state.

The special states are the following:

- Fault
- Warm up
- Configuration/Calibration
- Factory Reset

WARNING!

Detector is not monitoring gas during special states.

Failure to follow this warning can result in serious personal injury or death.

4.8 Testing the Network

Test the network before deployment to verify proper functioning.

- (1) Send an evacuation signal to all detectors.
- (2) Verify that all detectors respond.
 - a) Confirm the number of detectors ready to deploy matches the number of detectors in the app.
Connected detector LEDs illuminate green.

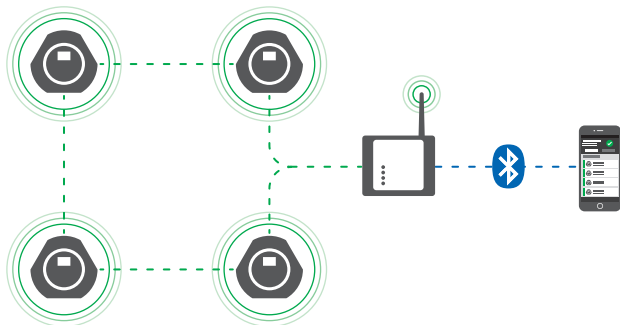

Fig. 9 Network Connection Overview

Before deploying the detectors onto the work site, ensure that the network is connected and the detectors are configured.

5 Deployment

Deployment is the process of placing detectors and HUB(s) throughout the work site and to be used in an operational state. With the exception of the AC connector for the HUB, all other components are able to operate in hazardous locations.

The detector and HUB must be oriented upright and should avoid direct sunlight if possible.

Detectors must have SensorShield and SunShield installed during deployment. Prior to deployment, confirm that the detector is equipped with sensors to detect the target gases:

- (1) Note current gas reading. This is the initial gas reading.
- (2) Press the detector button to note next gas reading.
- (3) Continue to press detector button until the initial gas reading is displayed again.

Detectors must be oriented as shown below:



5.1 Network Detector Placement

5.1.1 Detector

The distance at which detectors are able to connect to another detector or HUB is reduced by physical obstructions between the detectors and environmental conditions.

Any mention of maximum connection distance is understood to be under ideal conditions.

The interface feedback on the detector is the correct method to verify connections not distance alone, e.g. network icon  and LED blinks green. The strength of signal bar can be used as a reference to indicate signal strength from a detector to the HUB or from to a detector to a nearby detector that is being used as a hop to the HUB.

Pushing the button on the detector will provide an updated status of the strength of signal bar within 20 seconds. This may be used to assist with placement around the work site.

There is a time delay for a detector to update its network connectivity status as indicated by its LED lights as follows:

- Connection lost, 3-5 minute delay.
- Connection acquired, 2 minute delay.

While deploying detectors, the top LED blinks green indicating the detector is connected to the HUB. If the color of the LED light changes to purple, this indicates the detector is not connected to the HUB. Move closer to the HUB until the LED blinks greens indicating the connection is established or place another detector from the same network in-between to facilitate a hop. A hop is defined as a communication to the HUB by using a neighboring detector as a repeater to reach the HUB.

⚠ WARNING!

Introduction of obstructions (for example vehicles) between detectors and/or the HUB after deployment can prevent connection to the network of the obstructed detector and neighboring detectors. Selection of detector location and worksite controls must be used to prevent introduction of obstructions. Failure to follow this warning can result in serious injury or death.

A detector must be within the range of the HUB in order to be a part of the network. Under ideal line of sight conditions, the range is up to to 300 meters (1000 feet) HUB to detector.

Detectors that are out of range of the HUB are able to make up to two hops through neighboring detectors to extend the range. An example of this is shown below:

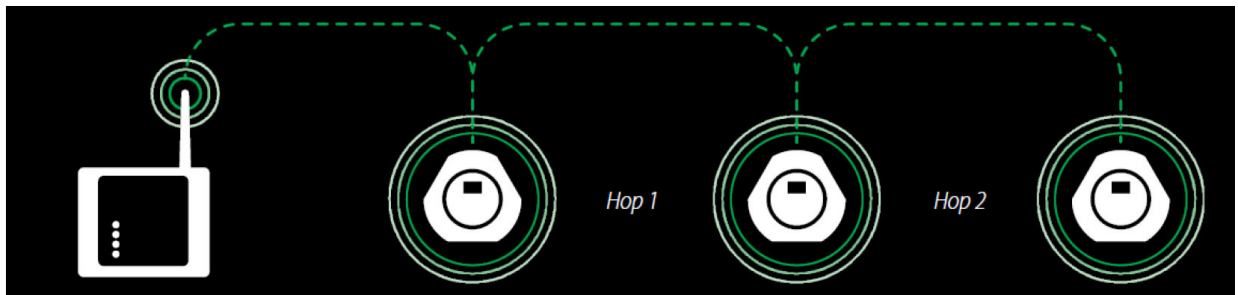

Fig. 10 Maximum Network Range

5.1.2 Disclaimers

Connectivity will be impacted by obstructions common to work sites such as: concrete walls, tanks vessels, piping, corrugated metal, steel framing, rain and humidity.

Detectors that drop from the network will continue to monitor gas readings, alarm individually, and store data logs internally. Shared alarms will not function for detectors not connected to the network. The HUB and detectors will automatically reestablish a connection, if possible.

⚠ WARNING!

A SensorShield must be installed on detector(s) in all situations where the detector(s) may be subject to conditions that could lead to blockage of the sensor path (including, but not limited to, rain, water spray, dusty or dirty environments, snow and ice storms or icing conditions). Failure to do so may result in erroneous gas readings or inability to detect a gas event.

Deployment

5.2 Environmental Considerations

5.2.1 SunShield

The SunShield is required on detectors to avoid exceeding maximum operating temperature and/or false alarms. The SunShield is securely held in place by the magnet on the back of the detector as shown below. With the SunShield installed, the D-ring and magnet can still be used for installation.



Fig. 11 SunShield

5.2.2 HUB

The HUB placement:

- Ambient temperature range: -20°C to +60°C
- Humidity Range: 10 to 95 % r.H. (non-condensing)
- Environments classified as pollution degree 1 or 2

Avoid exposure to weather to reduce excessive wear.

WARNING!

The HUB is designed and intended for use where the altitude is less than 2,000m (6,500 ft). Use of the HUB above this altitude can result in current surges, temporary over-voltage, and arcing which can result in a loss of HUB functionality and fire.

Failure to follow this warning can result in serious personal injury or death.

Powering the HUB

Option 1:

- (1) Connect Ethernet (optional).

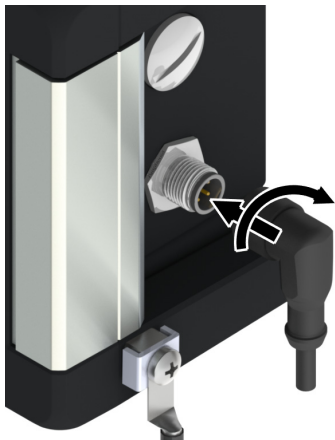

- (2) Connect Power to HUB assembly.

- (3) Connect power to mains supply in non-hazardous location.

Option 2:

- (1) Power the HUB in a non-hazardous location.
- (2) Move the HUB to its mounting location.

Mounting the HUB



After the HUB is powered, mount HUB to its final location. Mount HUB to its final location is valid for both option 1 and 2. It needs to follow option 1 and 2.

Use four screws to fasten the wall brackets to the surface and apply a torque of 45 in-lb +/- 5 in-lb (5 Nm +/- 1 Nm).

NOTE: It is the customer's responsibility to ensure the mounting system is properly chosen and installed such that it is capable of supporting 20 pounds of weight. Ensure the connectors and wires are supported to remove the stress and strain on the HUB.

5.2.3 Detector Mounting

WARNING!

Do not use attachment methods containing spark producing materials including but not limited to magnesium.

Failure to follow this warning can result in serious personal injury or death.

Place the detector using the D-ring or the magnet. Attachment methods include but limited to carabiners, S-hooks, and/or cable ties. It is the user's responsibility to choose an attachment method suitable in a potentially explosive atmosphere.

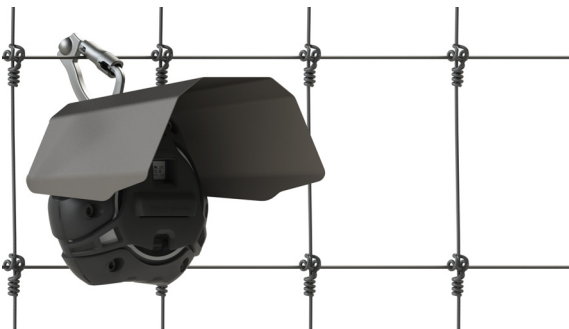

Fig. 12 D-Ring Mount

Deployment

The back of the detector has a magnet that can be used for gently placing the detector on appropriate surface.



Fig. 13 Magnet Mount

5.3 Mobile Device Assisted Deployment

While the app is not required for deploying a network, using the app offers the following benefits.

- GPS location can be recorded during deployment for safety io Grid users only
- Create a note in the app about detector placement
- Test evacuation notices

5.3.1 Network Connectivity

For each detector(s):

- Verify the connectivity icon and LEDs blink green
- Verify with the app that the quantity of detectors connected to the HUB match the quantity of detectors deployed
- If applicable, send evacuation to network and verify that detectors respond with evacuation alarm

Verify that HUB illuminates MSA Radio Connection LED.

US

6 Operation



Observe proper time for gas reading to stabilize. Response times vary based on the type of sensor being utilized.



While operation, the detector will emit a slight clicking sound intermittently. This is normal and is due to the detector continually self-checking its functionality.

6.1 Detector

6.1.1 Interfaces

The detector is operated by a combination of the button, the Calibration Cap, the app, and the Safety io Grid.

6.1.2 Button

The single button on the face of the detector controls the following:

Result	Start State	Action
Powers on	Off	(1) Hold button approximately 3 seconds. (2) Release.
Powers off	On	(1) Hold button approximately 3 seconds. (2) Release.
Interactive mode activated: Bluetooth radio broadcasting*, Display front light illuminates, RFID reader activates	On	(1) Press button briefly. (2) Release.
Initiate Calibration or Bump	On	(1) Press button briefly. (2) Release. (3) Present desired RFID tag.
Advance to next gas reading	Interactive mode and no special states	(1) Press button briefly. (2) Release.
Acknowledge alarm/alert**	Alarm/alert State	(1) Press button briefly. (2) Release.
Accept detector configuration	Pending configuration	(1) Press button briefly. (2) Release.
Factory reset	Power up	(1) Hold button approximately 12 seconds. (2) Release.
Sensor missing accept	Power up	(1) Press button briefly. (2) Release.
Fault***	On	Button is pressed for approximately 30 seconds











* When the button is pressed, detector will broadcast Bluetooth for approximately five minute, RFID communicates for 1 minute.

** If there are multiple gas alarms, the user can acknowledge alarm only when the display shows "Clear".

*** In event the button is stuck pressed, the detector enter a fault state to preserve battery life. Restart the detector and resume operation.

Factory reset will return detector to all factory settings, all network connections to the HUB will be disconnected, data logs will not be deleted.

6.1.3 Detector Display Icons

Icon	Description
	Alarm triggered and calibration failure
	High Alarm
	Low Alarm
	Processing event
	App connected to detector via Bluetooth
	Connected to network
	Connection strength indicators
Low Battery Warning	Battery Warning
Low Battery Alarm	Battery Alarm
	Fail, no
	Pass, yes
	Retry
	Sensor Life and Health
+++ %VOL O2	Sensor Over Range
--- %VOL O2	Sensor Under Range
XXX %LEL COMB	Sensor locked

US

6.1.4 Detector LED Definition

Use the combination of the LEDs and detector display to evaluate the state of the detector.

Usage	LED Behavior	Horn Behavior
No network connection	Top LED flashes purple every 15 seconds	Silent
Connected to a HUB	Top LED flashes green once every 15 seconds	Silent
Connected to Bluetooth	Top LED flashes blue	Silent
Low alarm has occurred	All LEDs flash red	Always sounding
High alarm has occurred	All LEDs flash red	Always sounding
Evacuation/shared alarm	All yellow with a LED circling, followed by all red with a LED circling	Always sounding
Calibration in process	LEDs flash blue clock-wise around the detector	Silent
Calibration passed	Green circling	Successful beep
Calibration failed	Red circling	Failure beep
Maintenance due	Side LEDs flash yellow	Silent
Battery Warning	Side LEDs flash yellow	Silent
Battery Alarm	Side LEDs flash yellow	Silent
Fault	All LEDs flash red	Short beep
Indicates that the detector is power up before normal operation	LEDs flash vertically up the detector	Silent
Indicates that the detector is power down before going off	LEDs flash vertically down the detector	Silent
Factory Reset	LEDs flash yellow counter-clockwise around the detector	Silent
Software update	LEDs illuminate yellow counter-clockwise around the detector	Silent
Configuration	LEDs illuminate yellow counterclockwise around the detector	Silent
Datalog download	LEDs illuminate yellow counterclockwise around the detector	Silent

LED Pattern Priorities

The following table lists the LED patterns in a priority order. Patterns at the top have higher priority than those below.

Normal State Patterns
High Alarm
Low Alarm
Evacuate and Shared Alarms
Maintenance
Blue Heartbeat
Green Heartbeat
Purple Heartbeat

6.2 Sensor Alarms

If the gas concentration reaches or exceeds the alarm set point, the detector will alarm.

There are two alarm levels: low alarm and high alarm.

6.2.1 Sensor Missing Alarm

The detector alerts the Sensor Missing alarm if the detector detects that the sensor is not properly installed in the detector or is not functional. During power on, if a sensor is detected as missing, the detector display prompts the user of "Sensor Change?". If sensor was intended to be removed, press the detector button to acknowledge the missing sensor. If the detector button is not pressed at when prompted the detector will enter Fault state 20. The Sensor Change can be acknowledged but restarting and pressing the detector button when prompted.



Reminder: The detector must be calibrated every time the front housing is separated from the battery holder.

6.2.2 Sensor End of Life Warning

If a sensor is nearing its end of life, the detector will warn the user following a sensor calibration by displaying the heart warning. The sensor is still functional, but the warning gives the user time to plan for a replacement sensor and minimize downtime. The heart symbol will be continuously displayed on the detector display. To determine which sensor is End of Life, press the detector button to advance gas reading until the second heart is displayed on that display screen as shown below.

If a combustible sensor requires replacement, view the detector status on the mobile app or the Safety io Grid to determine which sensor requires replacement.

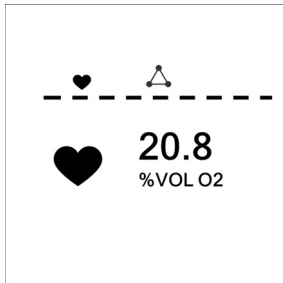

6.2.3 Sensor End of Life Indicator

If the detector cannot calibrate one or more sensors, the detector will display "Span Fail" followed by the Alarm symbol and heart symbol to indicate end of sensor life.

Failed calibration displays as alarm bell ringing.

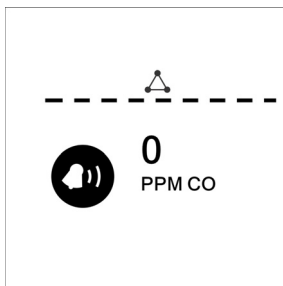

6.2.4 Exceed High and Low of Sensor

When a gas reading exceeds the full scale range of the sensor, the detector displays can "XXX" or "+++" in place of the actual reading.

When a gas reading falls below a defined under-range threshold, the detector displays " ---" in place of the actual reading.

XXX %LEL COMB	For combustible sensors, the sensor reading is in locked alarm.
------------------	---

+++ %VOL O2	The sensor reading is in over-range.
----------------	--------------------------------------

- - - %VOL O2	The sensor reading is in under-range.
------------------	---------------------------------------

For the combustible sensor to return to normal operation after the locked alarm, the detector must pass calibration. The over-range or under-range of a sensor will clear when the sensor reads gas reading within the normal range, i.e. no action is needed from the user.

6.3 Monitoring Oxygen Concentration

The detector monitors the oxygen concentration in ambient air. The alarm set points can be set to activate on two different conditions:

- Enriched - oxygen concentration > 20.8 % or
- Deficient - oxygen concentration < 19.5 %.

While the detector can detect up to 30 % oxygen in the ambient air, it is approved for use only up to 21 % oxygen-content.

The LOW alarm (oxygen deficient) is non-latching and will automatically reset when the O₂ concentration rises above the LOW set point.



If the alarm condition still exists, the button only silences the alarm for five seconds.

False oxygen alarms can occur due to changes in barometric pressure (altitude) or extreme changes in ambient temperature.

It is required that an oxygen calibration be performed at the room temperature. Be sure that the detector is in known fresh air before performing a calibration.

6.4 Monitoring Combustible Gases

The detector has been optimized for combustible gases that have a flash point below -60 °C/ -76 °F. These are typically gases like Hydrogen, Acetylene, Propane, Ethane, Butane and Methane. For combustible gases that have a flash point higher than -60 °C/ -76 °F, the detector will detect the gases, but the t90 times are not optimal.

Gas Type	Cross Reference Factor for calibration gas with 2.5 % vol methane
Methane	1
Propane	1.4
Hydrogen	1.1
Acetylene	1.2
Butane	1.6

Response Notes

- 1) Some compounds may reduce the sensitivity of the combustible gas sensor by poisoning or inhibiting the catalytic action or by polymerizing on the catalytic surface.
- 2) Multiply the displayed % LEL value by the conversion factor above to get the true % LEL.
- 3) These conversion factors should be used only if the combustible gas is known.
- 4) These conversion factors are typical. Individual units may vary by ± 25 % from these values.
- 5) The results are intended for guidance only. For the most accurate measurements, a device should be calibrated using the gas under investigation.

The detector displays the combustible gas concentration in % LEL or % Vol CH₄ on the Measuring screen until another screen is selected or the detector is turned off.

WARNING!

A combustible gas reading of "100" or "5" indicates the atmosphere is above 100 % LEL or 5.00 % Vol CH₄ respectively, and an explosion hazard exists. Move away from contaminated area immediately. Failure to follow this warning can result in serious personal injury or death.



Check your national standard values for 100 % LEL (EN60079-20-1).

6.5 Environmental Factors

A number of environmental factors may affect the gas sensor readings, including changes in pressure, humidity and temperature. Pressure and humidity changes affect the amount of oxygen actually present in the atmosphere.

6.5.1 Pressure Changes

If pressure changes rapidly (e.g., stepping through airlock), the oxygen sensor reading may temporarily shift and possibly cause the detector to go into alarm. While the percentage of oxygen may remain at or near 20.8 % Vol, the total amount of oxygen present in the atmosphere available for respiration may become a hazard if the overall pressure is reduced by a significant degree.

6.5.2 Humidity Changes

If humidity changes by any significant degree (e.g., going from a dry, air conditioned environment to outdoor, moisture laden air), oxygen readings can be reduced by up to 0.5 %, due to water vapor in the air displacing oxygen.

The oxygen sensor has a special filter to reduce the effects of humidity changes on oxygen readings. This effect will not be noticed immediately, but slowly impacts oxygen readings over several hours.

6.5.3 Temperature Changes

The sensors have built-in temperature compensation. However, if temperature shifts dramatically, the sensor reading may shift.

6.6 Data

During detector operation the typical data is recorded for analysis and review, which includes:

- Alarm set points
- Alarms event, acknowledge, and clear
- Evacuation event, acknowledge, and clear
- Battery warning and battery warning acknowledge
- Battery alarm and battery alarm acknowledge
- Battery shutdown
- RFID read events
- Time synchronize events
- Enter and leave configuration mode
- Enter and leave calibration mode
- Calibration information
- Faults
- Bluetooth (BLE) connection change
- Combustible sensor activated
- Network connection changes
- Sensor locked alarms
- Time and date of events

6.6.1 Data Log

Data logs are streamed from the HUB to the Grid at 2 minute intervals for networks that are connected to the Grid.

Detectors store gas reading data internally. Default periodic data log intervals are 30 minutes. The periodic data log includes a peak and average reading for each interval. The interval sampling rate can be adjusted in the app and associated log duration is as follows:

Interval	Log Duration
5 minutes	6.4 days
15 minutes	19 days
30 minutes	38 days
45 minutes	57 days
60 minutes	76 days

To retrieve data:

- (1) Press the detector button to enter interactive mode.
- (2) Connect to app.
 - a) Follow app prompts to retrieve data.
 - If using Grid, data is stored directly to Grid account.*
 - If no account is set up, the user can download data in CSV format.*

6.7 HUB

The HUB is operated with an external supply voltage of 24 V DC.

The HUB must only be operated in the ambient temperature range and at the relative humidity (non-condensing) specified.

A sudden power failure can cause a loss of data of the last minutes if operating data is saved periodically.



The HUB must only be operated with a distance of at least 20 cm to the user's body.

The HUB must only be used with approved antennas.

6.7.1 Factory Reset

If the device access password has been lost and no further access is possible, a factory reset can be performed to reset all values to their defaults.



(1) Power off the HUB.



(2) Unmount the HUB.

a) If necessary, move to a non hazardous location.



(3) Open housing by opening the right joints and unscrew the lid screws using a Torx T20.

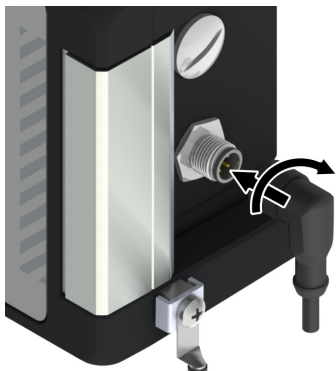

(4) Power the device.

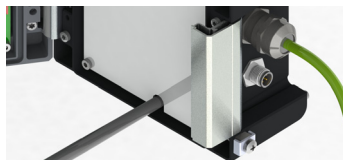

- (5) Use a thin object non-conductive to push the reset button for 10 seconds. All LEDs switch on and off.



- (6) Power off the HUB.

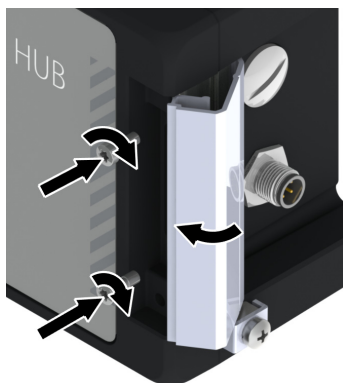

- (7) Close housing lid by tightening the lid screws with a torque of 13 in-lb +/- 1 in-lb (1.5 Nm. +/- 0.1 Nm).
- (8) Close joint.

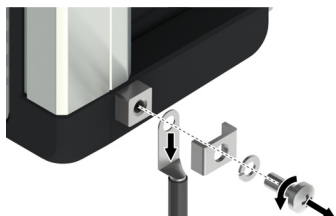

- (9) Install grounding Clamp.
 - a) Remove grounding clamp.
 - b) Insert grounding cable and re-tighten grounding clamp with a torque of 17 in-lb +/- 1 in-lb (2 Nm +/- 0.1 Nm).



- (10) Mount HUB to its final location. Use four screws to fasten the wall brackets to the surface and apply a torque of 45 in-lb +/- 5 in-lb (5 Nm +/- 1 Nm).

NOTE: It is the customer's responsibility to ensure the mounting system is properly chosen and installed such that it is capable of supporting 20 pounds of weight. Ensure the connectors and wires are supported to remove the stress and strain on the HUB.

- (11) Power the HUB following the steps in section "Powering the HUB" (5.2.2 "HUB").

7 Calibration and Bump

WARNING!

Detectors will **not** be performing hazardous gas sensing operations while calibrating. Failure to follow this warning can result in serious personal injury or death.

The detector must equilibrate to room temperature before calibration.

Event Induced Calibration

Calibrate detector(s) each time the batteries are changed, after every factory reset of the detector(s), and every time the detector(s) is subjected to physical shock.

Calibration Time Guide

If the detector(s) is bump tested daily, MSA recommends calibrating the detector(s) at least every six months. MSA recommends detector calibration every 30 days if bump testing occurs infrequently. Bump test frequency may be stipulated by national regulations.

Calibration Certification

All applicable inspections, testing, and calibrations were performed using NIST traceable equipment, where available, in accordance with MSA's ISO 9001 Certified Quality System.

7.1 Bump Test

WARNING!

Perform Bump Test per the instructions in this manual. Failure to perform this test can result in serious personal injury or death.

This test quickly confirms that the gas sensors are functioning.

7.1.1 Bump Test Frequency

Bump test frequency may be stipulated by national regulations. In the absence of national standards, corporate regulations must stipulate bump test frequency. Bump testing must be conducted at a minimum before each deployment of a device.

When use conditions permit, bump testing should be performed daily.

If tested, the device must pass the bump test. If it fails the test, perform a calibration before using the device.

A bump test must be performed more frequently than daily if any of the following occur:

- The device is subjected to high levels of contaminants.
- The device is subjected to rain or water spray.
- The tested atmosphere contains the following materials, which may desensitize the combustible gas sensor and reduce its readings:
 - Organic silicones
 - Silicates
 - Lead-containing compounds
 - Hydrogen sulfide exposures over 200 ppm or exposures over 50 ppm for one minute
 - Rain
- The SensorShield is not installed.
- The device is exposed to conditions that could lead to blockage of the sensor path (including but not limited to snow and ice storms, icing conditions, rain or water spray, dusty or dirty environments).

CSA requires (per 22.2 NO. 152) that combustible sensor sensitivity be tested before each day's use on a known concentration of methane equivalent to 25 to 50 % of full scale concentration. ACCURACY MUST BE WITHIN 0 to +20 % OF ACTUAL. Correct accuracy by performing the calibration procedure described in section 7.2.1 "Calibration".

7.1.2 Equipment

See section 13.1 "Detector Spare Parts and Accessories" for ordering information of these components:

- Calibration Check Gas Cylinder
- 0.25 liters/min. Flow Regulator
- 1/8" ID Superthane Ester Tubing
- Calibration Cap

NOTICE

Use a calibration gas with a 2.5 % methane concentration to ensure optimal detector performance. Calibrating a combustible sensor with a concentration below 2.5 % may decrease the battery life at an increased rate if low levels of background gas are present.

7.2 Performing a Bump Test



(1) Remove SunShield.

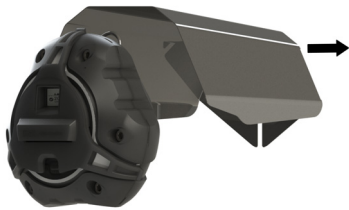

(2) Remove SensorShield.



- (3) Press the button to activate Interactive mode and start Bluetooth communication.



- (4) Tap the Bump RFID tag in Calibration Cap to the button.



Once prompted, a detector will display 'Install Cap', at which time Install the calibration cap.



- (5) Snap the Calibration Cap onto the detector.
- (6) Insert tab on Calibration Cap into slots on detector (3 places).
- (7) Press Calibration Cap until it seats onto detector.
 - a) If needed, connect one end of the tubing to the Calibration Cap.
 - b) If needed, connect other end of tubing to the cylinder regulator.

US

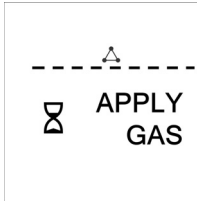

(8) When the detector shows blue LEDs and prompts 'Apply Gas', apply gas.

(9) Open valve on regulator to allow gas to flow to detector.

After bump test completes, the detector will:

Pass:

- Beep
- Display green LEDs
- Display check mark and "Bump Pass" text

Fail:

- Beep
- Display red LEDs
- Display "X" and "Bump Fail" text

If the bump test fails, the detector will automatically attempt a second bump test.

(10) Turn off gas.

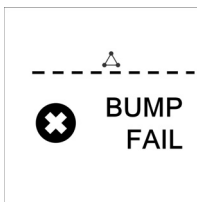
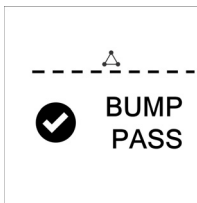

⚠ WARNING!

Do not continue operation of a detector that is not able to pass a bump test. Failure to follow this warning can result in serious personal injury or death.



(11) Remove Calibration Cap.

US



- (12) Once complete, install SensorShield.
- Insert tabs on SensorShield into slots on detector (3 places).

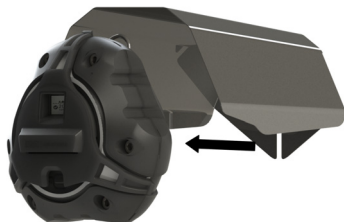

- (13) Install SunShield on detector.



7.2.1 Calibration

Calibration must be performed using a flow regulator with a flow rate set to 0.25 liters per minute.



Under normal circumstances MSA recommends calibration before each deployment. Please check your national legislation.

Calibrate at room temperature. Allow detector(s) to stabilize for 30 minutes before calibration. Stated calibration performance is for room temperature.

Equipment

For Part Numbers, see section 13.1 "Detector Spare Parts and Accessories".

- Calibration Check Gas Cylinder
- 0.25 liters/min. Flow Regulator
- 1/8" ID Superthane Ester Tubing
- Calibration Cap



The calibration procedure adjusts the zero and span values for any sensor that passes the calibration test; sensors that fail calibration are left unchanged. Since residual gas may be present, the detector may briefly go into alarm after the calibration sequence is completed.

Calibration Steps



(1) Remove SunShield.

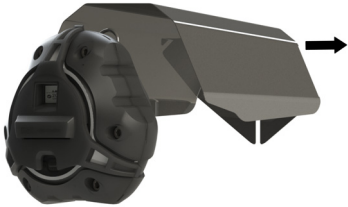

(2) Remove SensorShield with the detector exposed to fresh air.
NOTE: If uncertain, use a bottle that contains fresh air.



(3) Press button on the detector to enter interactive mode.



(4) Tap the Cal RFID tag in Calibration Cap to the button.



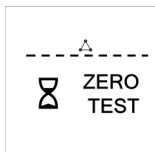

Once the Cal RFID tag is read, a Zero calibration will initiate. Screen will display 'Zero Test' and LEDs will flash blue.

NOTE: Do not install the Calibration Cap during Zero Calibration!

After Zero calibration completes, the detector will:

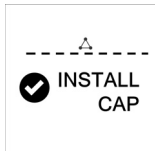

Pass:

Check mark and 'Install Cap' text are displayed.

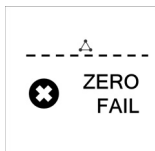

Fail:

- Beep
- Display red LEDs
- Display 'X' and 'Zero Fail' text



During zero calibration the O₂ sensor is also span calibrated to 20.8 % O₂ fresh air, adjusting the calibration curve as needed. During span calibration, the O₂ sensor's accuracy is checked against a known oxygen gas concentration without adjusting the calibration curve.

Span Calibration

Span calibration immediately follows a Zero calibration.



A span calibration can fail for many reasons besides sensor at the end of his life. If a span calibration failure occurs, items such as remaining gas in the calibration cylinder, gas expiration date, security of the Calibration Cap, etc. should be verified and calibration should be repeated prior to replacing the sensor.



- (1) Snap the Calibration Cap onto the detector.
- (2) Insert tab on Calibration Cap into slots on detector.
- (3) Press Calibration Cap as shown until it seats onto detector.
 - a) If needed, connect one end of the tubing to the Calibration Cap.
 - b) If needed, connect other end of tubing to the cylinder regulator.



The detector will show blue LEDs and display 'Apply Gas'.



- (4) Open valve on regulator to allow gas to flow to the detector.
The duration of the application of the calibration gas is controlled by the detector.
The detector will indicate that calibration span has successfully passed and that the gas can be removed.

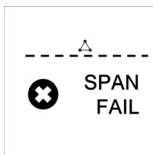
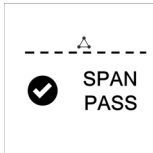

After span calibration completes, the detector will

Pass:

- Beep
- Display green LEDs
- Display check mark and 'Span Pass' text

Fail:

- Beep
- Display red LEDs
- Display X and 'Span Fail' text

NOTE: If calibration fails, the detector will automatically attempt a second calibration.

If the detector span retry fails a second time:

- Span fail
- Alarm bell

WARNING!

Do not continue operation of a detector that is not able to pass calibration. Failure to follow this warning can result in serious personal injury or death.

- (5) Turn off gas.



- (6) Remove calibration cap.



(7) Install SensorShield on the detector.

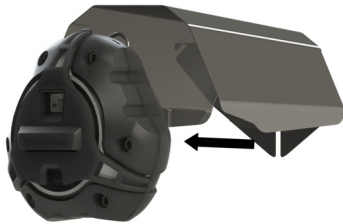

(8) Install SensorShield.



WARNING!

A SensorShield must be installed on detector(s) in all situations where the detector(s) may be subject to conditions that could lead to blockage of the sensor path (including, but not limited to, rain, water spray, dusty or dirty environments, snow and ice storms or icing conditions). Failure to do so may result in erroneous gas readings or inability to detect a gas event. Failure to follow this warning can result in serious personal injury or death.

8 Maintenance and Service

Clean the detector and/or HUB before any maintenance or service.

WARNING!

Do not use silicone-type lubricants in assembling the detector and do not allow silicone vapors to be drawn into the flow system while in operation. Silicone can desensitize the combustible gas sensor, thereby giving erroneously low readings.

Use only genuine MSA replacement parts when performing any maintenance procedures on the detector. Substitution of components can seriously impair performance.

Failure to follow the above can result in serious personal injury or loss of life.

WARNING!

Alterations of the HUB beyond the procedures described in the Setup, Deployment, Operation, and Decommissioning sections of this manual or by anyone other than a person authorized by MSA, could cause the unit to fail to perform properly.

Repair of the HUB must be performed by a person authorized by MSA.

Failure to follow this warning can result in serious personal injury or death.



MSA recommends always using the latest app.



Refer to EN 60079-29-2 (Guide for the selection, installation, use and maintenance of apparatus for the detection and measurement of combustible gases or oxygen) and EN 45544-4 (Guide for the selection, installation, use and maintenance of electrical apparatus used for the direct detection and direct concentration measurement of toxic gases and vapors).

8.1 Tools Required

- 5 mm hex key
- #1 Phillips head driver
- 3/16" slotted driver
- T20 torx driver
- Torque wrench

8.2 Authorized Maintenance

Any authorized maintenance shall be performed in a non-hazardous area with HUB(s) and detector(s) powered off. Clean the detector and/or HUB before any maintenance or service. Power off the HUB and the detector before any further maintenance. Clean the detector and/or HUB before any further maintenance. Observe proper grounding techniques to avoid damage caused by static discharge to the exposed electronics. Orient the detector and/or HUB such that the printed circuit board is not accessible during maintenance.

WARNING!

Before handling the PC board, ensure you are properly grounded; otherwise, static charges from your body could damage the electronics. Such damage is not covered by the warranty.

Failure to follow this warning can result in serious personal injury or death.

8.3 Detector

If an error occurs during operation of the detector, use the displayed error codes to determine appropriate next steps.



While detector case is open, do not touch any internal components with metallic /conductive objects or tools.

Damage to the detector can occur

8.3.1 Routine Cleaning for Detector

Clean the exterior of the detector regularly using only a damp cloth. Do not use cleaning agents, as many contain silicone, which will damage the combustible sensor. Cleaning is required to ensure optimal performance.

8.3.2 Routine Cleaning of Dust Build up on the Magnet

Use a damp cloth to periodically remove dust from the magnet.

8.4 Dust and Dirt Exposure

Use a dry, soft bristled brush to remove any dust or dirt that has accumulated on the detector, especially at the sensor openings. If there is a buildup of dust or dirt particles remaining in the sensor area after brushing, use a vacuum to remove remaining particles, but maintain at least a 1/2 inch (1.3 cm) distance from the gas detector.

8.5 Chemical Exposure

If the equipment is likely to come into contact with aggressive substances e.g. acidic liquids or gases that may attack metals or solvents that may affect polymeric materials, then it is the responsibility of the user to take suitable precautions that prevent it from being adversely affected.

8.6 Water Exposure

If water is noticed in the sensor cavity, turn the detector sensor side down and gently shake water off the sensor area. Any remaining water can be removed with a clean dry cloth. In the event that the detector is immersed in water, allow the sensor inlets time to dry before retesting and returning to service. Drying time is dependent upon humidity conditions and the duration of immersion.

8.7 Routine Cleaning for Detector Accessories

Use a dry, soft bristled brush to remove any dust or dirt that has accumulated on the SunShield, the SensorShield, Sensor plug, and the Calibration Cap.

8.8 Batteries

Observe Proper Battery Maintenance

WARNING!

Follow all instructions related to use and handling of batteries. Improper use and handling can result in battery leakage, battery venting, explosion or fire.

Use only Tadiran model number TL-5920 and Tadiran model SL-2770. MSA Part number 10201430. Use of another battery may present a risk of fire or explosion.

When replacing batteries of a detector, do not mix old and new batteries. Always replace all batteries of a detector when needed. Do not mix battery lots - check battery label for lot information.

Do not drop bare cells.

Failure to follow this warning can result in serious personal injury or death.

The battery shall not be replaced in a hazardous area. Only use Tadiran model number TL-5920 and Tadiran model SL-2770. MSA Part number 10201430.

Observe the following when using and handling the batteries:

- Do not insert batteries in reverse. Observe the + and - markings on the battery and on the device.
- Do not short circuit the batteries.
- Do not charge the batteries.
- Do not force discharge the batteries.
- Do not leave discharged batteries in the device.
- Do not overheat the batteries.
- Do not open the batteries.
- Do not deform the batteries.
- Do not expose the batteries to water.
- Do not encapsulate and/or modify the batteries.
- Store batteries in their original packaging away from metal objects. If already unpacked, do not mix or jumble batteries.



- (1) Power off the detector.
- (2) Press the button for approximately 3 seconds and release.



- (3) Remove the housing screws (6 places) with a 5 mm hex key.



- (4) Separate the front and back housing.
 - a) If needed, gently insert the slotted screwdriver into the slots shown. Do not exceed more than $\frac{1}{4}$ " of penetration.
 - b) Do not pry where the shield attaches.
 - c) Rotate screwdriver apart slightly at each appropriate pry location.



- (5) Gently pull batteries out of the cavities (3x).



- (6) Install new batteries into the cavity oriented such that the battery matches the orientation marked in the cavity.



- (7) Assemble front and back housing. Install screws until resistance starts.



- (8) Finish tightening screws in the pattern as shown below.
Tighten screws to a torque of 10 in-lb +/- 1 in-lb (1.1 Nm +/- 0.1 Nm).

- (9) Dispose of used batteries promptly.
Observe local disposal regulations.
Do not disassemble and do not dispose of in fire.

8.9 Gasket Replacement

Observe all maintenance precautions. The gasket shall not be replaced in a hazardous area.



- (1) Power off the detector.
Press the button for approximately 3 seconds and release.



- (2) Remove the housing screws (6 places) with a 5mm hex key.



- (3) Separate the front and back housing.
 - a) If needed, gently insert the slotted screwdriver into the slots shown. Do not exceed more than $\frac{1}{4}$ " of penetration.
 - b) Do not pry where the shield attaches.
 - c) Rotate screwdriver apart slightly at each appropriate pry location.



- (4) Gently pull batteries out of the cavities (3x).

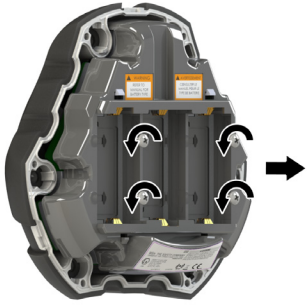

(5) Remove battery holder retaining screws.

(6) Separate the front housing from the battery holder.

(7) Remove old gasket.



(8) Install new gasket by orienting the open ring around the opening for the horn.

Always replace the gasket when servicing the horn or sensors.

(9) Assemble front housing to battery holder.

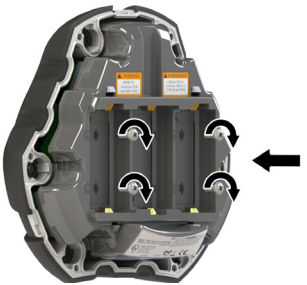

(10) Install screws to torque of 3 in-lb +/- 0.5 in-lb (0.3 Nm +/- 0.1 Nm).



(11) Install new batteries into the cavity oriented such that the battery matches the orientation marked in the cavity.

See reference and warnings in section 8.8 "Batteries".



(12) Assemble front and back housing. Install screws until resistance starts.

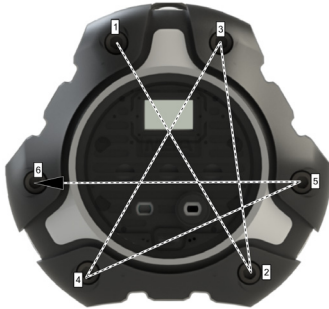

(13) Finish tightening screws in the pattern as shown below.
Tighten screws to a torque of 10 in-lb +/- 1 in-lb (1.1 Nm +/- 0.1 Nm).

(14) Dispose of gasket following local regulation.
Do not reuse the gasket.

⚠ WARNING!

The detector must pass calibration before continuing use.
Failure to follow this warning can result in serious personal injury or death.

US

8.10 Sensors

The only routine maintenance item is the sensing element itself, which has a limited lifetime. The detector will indicate when the sensor is near end of life through the detector display. When the Sensor Life & Health status is "Warning", there is a limited amount of time to replace the sensor before it will no longer function. When a sensor is no longer capable of sensing it will go into maintenance and LEDs will flash yellow. It is good practice to obtain a replacement sensing element before the sensing element within your unit becomes inoperative.

WARNING!

Remove and reinstall sensors carefully, ensuring that the components are not damaged; otherwise detector intrinsic safety may be adversely affected, wrong readings could occur, and persons relying on this product for their safety could sustain serious personal injury or death.

Failure to follow this warning can result in serious personal injury or death.

WARNING!

Handle the sensor carefully; the electrochemical version is a sealed unit which contains a corrosive Electrolyte. Any leaked electrolyte that comes in contact with skin, eyes or clothes can cause burns. If any contact with the electrolyte does occur, immediately rinse with a large quantity of water. On contact with the eyes, rinse thoroughly with water for 15 minutes and consult a doctor.

Failure to follow this warning can result in serious personal injury or death.

WARNING!

Do not install a leaking sensor in the sensing head assembly. The leaking sensor must be disposed of in accordance with local, state and federal laws.

Failure to follow this warning can result in serious personal injury or death.

8.11 Sensor Maintenance

Do not block sensor openings as this may cause inaccurate readings.

Do not press on the face of the sensors, as this may damage them and cause erroneous readings.

Do not use compressed air to clean the sensor holes, as the pressure may damage the sensors.

8.12 Sensor Configurations

Mobile Sensor Configurations

Users have the option to change sensor configurations.

Detectors can be configured and/or reconfigured with the sensors desired.

Add or remove sensors combustible, low power combustible, toxic, and/or oxygen.

- (1) Move to a non-hazardous, clean air location.
- (2) Ensure the detector is powered on.
- (3) Press the button to activate Interactive mode.
- (4) Connect with the app.
- (5) Follow app prompts to complete sensor configuration.

Physical Sensor Configurations

WARNING!

Place Sensor plug into sensor slot if removing a sensor and not re-installing a sensor. Failure to follow this warning can result in serious personal injury or death.

i In order to detect combustible gas, both the low power combustible sensor and XCell Combustible sensor must be installed and enabled.

8.13 Replacing Sensors

WARNING!

Calibration is required after a sensor is installed; otherwise, the detector will not perform as expected and persons relying on this product for their safety could sustain serious personal injury or death. Failure to follow this warning can result in serious personal injury or death.

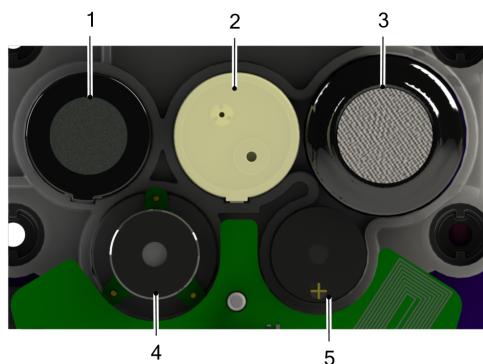

Fig. 14 Sensors

- | | | | |
|---|----------------------------|---|------------------------------|
| 1 | Combustible Sensor | 4 | Low power combustible sensor |
| 2 | Toxic Sensor or Dual Toxic | 5 | Horn |
| 3 | Oxygen Sensor | | |

Dual Combustible Sensors. The detector utilizes two combustible sensors that work in conjunction to maximize battery life. The low power combustible sensor and the combustible sensor are both required for operation. Both sensors utilize catalytic beads for combustible gas detection.

If a combustible sensor requires replacement, view the detector status on the mobile app or the Safety io Grid to determine which sensor requires replacement.



- (1) Power off the detector,
Press the button for approximately 3 seconds and release.

US



(2) Remove the housing screws (6 places) with a 5mm hex key.



(3) Separate the front and back housing.
 a) If needed, gently insert the slotted screwdriver into the slots shown. Do not exceed more than ¼" of penetration.
 b) Do not pry where the shield attaches.
 c) Rotate screwdriver apart slightly at each appropriate pry location.



(4) Gently remove batteries.

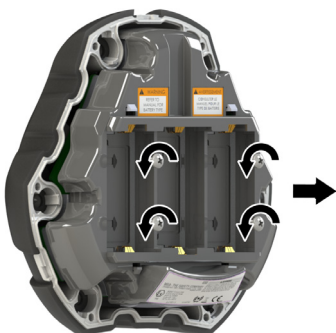

(5) Remove battery holder retaining screws.

(6) Separate front housing from battery holder.
 (7) Dispose of sensor gasket following local regulations.
 (8) Gently lift out and properly discard the sensor to be replaced. Using fingers only, gently remove the sensor.

US

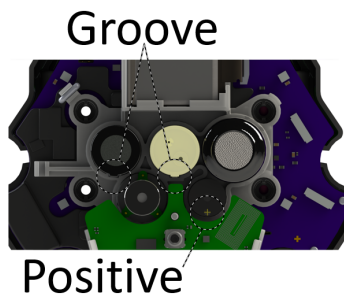

- (9) Carefully align the new sensor contact pins with the sockets on the printed circuit board and pressing it firmly in place.
 - a) Ensure tab on sensor aligns with groove at top of holder - applies to XCell sensors only.
 - b) Insert the Xcell combustible sensor as shown.
 - c) Insert the O₂ sensor as shown.
 - d) Insert the toxic sensor as shown.
 - e) Insert the low power combustible sensor as shown.

⚠ WARNING!

Calibration is required after a sensor is installed; otherwise, the detector will not perform as expected and persons relying on this product for their safety could sustain serious personal injury or death. Failure to follow this warning can result in serious personal injury or death.

- (10) Install new sensor gasket.

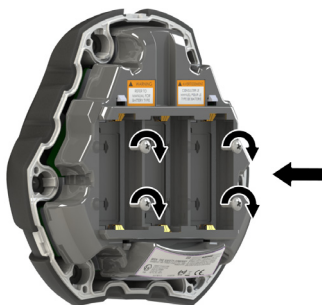

- (11) Install battery holder retaining screws and torque to 3 in-lb +/- 0.5 in-lb (0.3Nm +/- 0.1Nm).



- (12) Install new batteries into the cavity oriented such that the battery matches the orientation marked in the cavity.
See reference and warnings in section 8.8 "Batteries".



- (13) Assemble front and back housing.
Install screws until resistance starts.

US

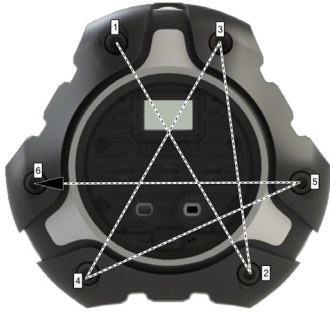

(14) Finish tightening screws in the pattern as shown.

Tighten screws to a torque of 10 in-lb +/- 1 in-lb (1.1 Nm +/- 0.1 Nm).

(15) Install SensorShield.

(16) Install SunShield.



When replacing O₂ sensor allow sufficient time for warm up before use.

8.14 Horn Replacement

Observe all maintenance precautions.

The horn shall not be replaced in a hazardous area.



(1) Power off the detector,

Press the button for approximately 3 seconds and release.



(2) Remove the housing screws (6 places) with a 5mm hex key.



- (3) Separate the front and back housing.
 - a) If needed, gently insert the slotted screwdriver into the slots shown.
Do not exceed more than ¼" of penetration.
 - b) Do not pry where the shield attaches.
 - c) Rotate screwdriver apart slightly at each appropriate pry location.

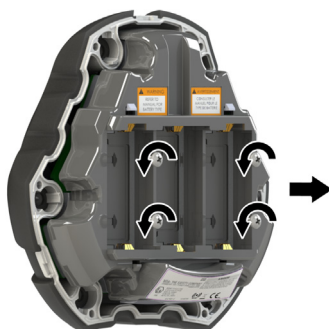

- (4) Remove battery holder retaining screws.

- (5) Separate front housing from battery holder.
- (6) Remove old sensor gasket.
Dispose of sensor gasket following local regulations.

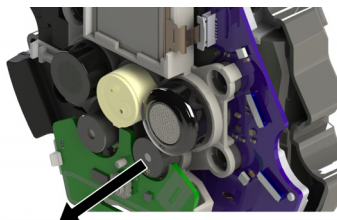

- (7) Gently remove the horn.
Do not pry in any manner to remove the horn.



- (8) Ensure that the horn area is free of debris before installing.
Align terminals as shown below and gently install the horn until fully seated. Positive terminal is oriented towards the lower part of the detector.



- (9) Replace the sensor gasket.

US

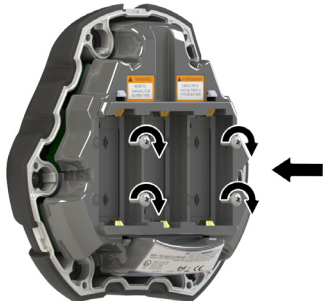

(10) Install screws with a torque of 3 in-lb +/- 0.5 in-lb (0.3 Nm +/- 0.1 Nm).



(11) Install new batteries into the cavity oriented such that the battery matches the orientation marked in the cavity.

See reference and warnings in section 8.8 "Batteries".



(12) Assemble front and back housing. Install screws until resistance starts.

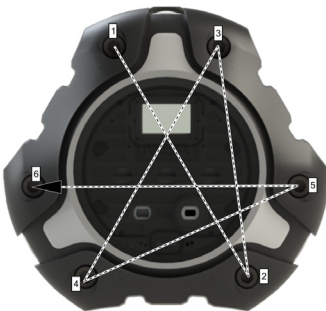

(13) Finish tightening screws in the pattern as shown.

Tighten screws to a torque of 10 in-lb +/- 1 in-lb (1.1 Nm +/- 0.1 Nm)

(14) Ensure horn has been properly installed by manually initiating an alarm with calibration gas or using the app to evacuate the detector and listen for an audible alarm.

a) Confirm in the app that the horn is configured "on" before testing.



Reminder: The detector must pass calibration before continuing use.

8.15 Storage

Follow decommission instruction. When not in use, store the detector in a safe, dry place between 18 °C (64 °F) and 30 °C (86 °F). After storage the detector must pass calibration before use.

WARNING!

Do not store the detector where silicone vapors are present or in the presence of silicone components, lubricants, cleaners or other substances containing silicone. Silicone can desensitize the combustible gas sensor, thereby giving erroneously low readings. Calibrate the detector upon removal from storage and prior to use.

The HUB contains silicone materials. Do not store the detector and HUB (including power cords and power supply) together in a container or bin. If the detector and HUB are stored in the same storage room, maintain 3 feet (1 meter) of separation between the detector and HUB.

Calibrate the detector upon removal from storage and prior to use.

Failure to follow these warnings can result in serious personal injury or death.

8.16 HUB

Repairs and maintenance must be carried out only by MSA. Consider to update the device firmware regularly. Be aware of the Procedures for Handling Electrostatically Sensitive Electronic.

WARNING!

Alterations of the HUB beyond the procedures described in the Setup, Deployment, Operation, and Decommissioning sections of this manual or by anyone other than a person authorized by MSA, could cause the unit to fail to perform properly.

Repair of the HUB must be performed by a person authorized by MSA.

Failure to follow this warning can result in serious personal injury or death.



The HUB contains electrostatically sensitive components. Do not open the HUB without using appropriate electrostatic discharge (ESD) protection. The warranty does not cover damage caused by electrostatic discharges.

8.16.1 Cleaning the HUB

Do not rub the device and never clean plastic surfaces with a dry cloth. Otherwise, electrostatic charges can occur and damage the device. Always use a damp cloth instead.

Avoid alcoholic and chemical detergents. Otherwise, the device may be damaged and the labels may be unreadable.

9 Decommissioning

9.1 Detector

9.1.1 Powering Down

- (1) Hold the button for approximately 3 seconds.
The detector turns off.
- (2) Follow the steps in section 8.8 "Batteries" to remove and store batteries.
- (3) Wrap battery terminals with electrical tape for storage.
- (4) Assemble front and back housings together.

9.1.2 Removing Individual Detectors from a Network

If using a stand-alone detector (without a HUB, that has been previously connected to a network), it will continue to search for the HUB and decrease battery life at an expedited rate.

To ensure normal battery life, use the mobile app to remove the detector from the network if using the detector as a stand-alone.

9.1.3 Reset Network Features

The user can reset network features via the app:

- Disconnect from HUB
- Detector location
- Password
- Resetting the detector to a blank network configuration

Follow instructions in section 4.2 "Connecting a Network" to interface with the app.

9.1.4 Factory Reset

Factory reset is an optional decommissioning step and can only be performed during detector power on.

- (1) Turn on the detector.



To perform factory reset, during power up:

- (2) Hold the button for approximately 12 seconds and release the button when the display says Reset.
- (3) Continue to hold the button to not perform factory reset.

9.1.5 Storage Conditions

When not in use, store the detector in a safe, dry place between 18 °C (64 °F) and 30 °C (86 °F). The relative humidity range of 15 % - 90 % relative humidity, non-condensing environment.

For extended storage, remove batteries and store separately in a safe, dry place.

WARNING!

Do not store the detector where silicone vapors are present or in the presence of silicone components, lubricants, cleaners or other substances containing silicone. Silicone can desensitize the combustible gas sensor, thereby giving erroneously low readings.

The HUB contains silicone materials. Do not store the detector and HUB (including power cords and power supply) together in a container or bin. If the detector and HUB are stored in the same storage room, maintain 3 feet (1 meter) of separation between the detector and HUB.

Calibrate the detector upon removal from storage and prior to use.

Failure to follow these warnings can result in serious personal injury or death.

9.2 HUB

WARNING!

- Do not connect or disconnect power and/or Ethernet connections to or from the HUB in a hazardous location. Connect or disconnect only in a non-hazardous area.
- Do not remove, replace or disconnect the HUB while the circuit is live.
- Do not open the HUB when the power supply is energized.
- Do not substitute components. Substitution of components may impair intrinsic safety.
- Do not open the HUB in a hazardous location.
- Do not connect or disconnect Ethernet connection when the power supply is energized.

Failure to follow these warnings can expose a user to risk of electrical shock or ignition of explosive atmospheres and can result in serious personal injury or death.



- (1) Unplug the mains power supply.
- (2) Power off the HUB.

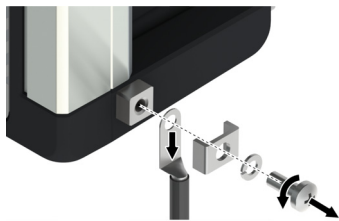

- (3) If present, unplug the Ethernet plug and install Ethernet plug.
- (4) Loosen grounding clamp and remove grounding cable.
- (5) Reattach grounding clamp.



(6) Remove antenna.

The HUB is decommissioned.

9.2.1 Storage Conditions

When not in use, store the HUB in a safe, dry place between 18 °C (64 °F) and 30 °C (86 °F).
The relative humidity range of 15 % - 90 % relative humidity, non-condensing environment.

10 Troubleshooting

10.1 Detector

The health indicator on the detector display of the combustible and low power combustible sensor are combined on the combustible screen. Use the app to determine which sensor has the health warning. Record the fault number and all other information on the detector display during fault to provide guidance to MSA customer support if needed.

Code	Cause	Corrective Actions
Fault 12	Oxygen sensor fault	Replace batteries, if low. If fault persists, replace with new MSA oxygen sensor. If fault still persists, contact MSA customer support.
Fault 13	Duo-tox sensor fault	Replace batteries, if low. If fault persists, replace with new MSA duo-tox sensor. If fault still persists, contact MSA customer support.
Fault 14	Combustible sensor fault	Replace batteries, if low. If fault persists, replace with new MSA combustible sensor. If fault still persists, contact MSA customer support.
Fault 15	Low power combustible sensor fault	Replace batteries, if low. If fault persists, replace with new MSA low power combustible sensor. If fault still persists, contact MSA customer support.
Fault 17	Detector button is stuck in the pressed position	Unstick the button. If fault persists, contact MSA customer support.
Fault 20	Sensor configuration not accepted	Accept sensor configuration during power up.
All other faults	MSA serviceable faults only	Contact MSA customer service for support.

Problem	Action
Calibration due on display	Calibrate
Detector will not turn on	Check/Change batteries
Horn does not sound	Replace horn
Fault on detector display	Refer to Code fault table above
Sensor warning	Replace sensor

11 Technical Data

11.1 Detector

Weight	27.2 oz / 771 g (detector with battery and clip)		
Dimensions (L x W x H)	5.2 x 5.6 x 2.7 inches/132 x 142 x 69 mm		
Alarms	Visible LEDs and 90 dB at 30 cm horn		
Display	LCD display		
Battery type	Primary Non-rechargeable Lithium battery. Only replace with Tadiran model number TL-5920 and Tadiran model SL-2770		
Detector run time	50-60 days at 25 °C (77 °F) any configuration with combustible sensor installed; 80-85 days at 25 °C (77 °F) toxic/O ₂ configurations only.		
	<ul style="list-style-type: none"> • Operation at the low and/or high temperatures • Continuously alarmed state with horn sounding and LEDs flashing • Continuous background level of gas present • Sensor drift (positive or negative) • Network connected detectors searching for offline HUB for extended period of time • Large sized networks reduce the battery runtime as follows: 		
	Detector per Network	17-24	25-32
	4 gas	41-49 days	34-41 days
toxic/O ₂ only	60-64 days	48-51 days	
Power up time	2 min during start-up procedure		
Temperature Range	Normal operating range:	14 to 104 °F (-10 to 40 °C)	
	Extended operating range:	-4 to 140 °F (-20 to 60 °C)	
	Intrinsic safety ambient temperature range (NA, ATEX, IEC):	-40 to +140 °F (-40 to 60 °C)	
	Storage:	32 to +95 °F (0 to 35 °C)	
Humidity Range	15 % - 90 % relative humidity, non-condensing, 5 % - 95 % RH intermittent		
Atmospheric pressure range	800 to 1200 mbar		
Ingress protection	IP 68 (2 meters for 60 minutes) IP ratings do not imply that the equipment will detect gas during and after exposure to these conditions		
Measuring methods	Combustible gases: Catalytic sensors		
	Oxygen: Electrochemical sensor		
	Toxic gases: Electrochemical sensor		
Measuring Range	Combustible:	0-100% LEL 0-5.00% Vol. CH ₄	
	O ₂	0-30% Vol.	
	CO	0-1999 ppm	
	H ₂ S	0-200 ppm	

11.2 MSA HUB

Dimensions (L x W x H)	5.2 x 5.6 x 2.7 inches/132 x 142 x 69 mm
Temperature range	-4 °F to 140 °F (-20°C to +60°C) for intrinsic safety Storage: 64 °F to 86 °F (18 °C to 30 °C)
Humidity	10 to 90 % r.H. (noncondensing)
Ingress protection	IP67
Power dissipation	Continuous: ≤ 5W Peak: ≤ 12W
Power Supply	Connector type: M12, 4-Pin, A-coded Minimal input voltage: 12 V DC Nominal input voltage: 24 V DC Maximal input voltage: 30 V DC
Ethernet	10 BASE-T/ 100 BASE-TX, galvanic isolated
Bluetooth	Bluetooth 4.0 Class 1.5
Wifi	Wi-Fi: IEEE 802.11 a/b/g/n

US

11.3 Factory Set Alarm Thresholds and Set Points



Check the monitor or calibration certificate for exact alarm levels as they vary depending on national or corporate regulations.

Sensor	Low Alarm	High Alarm	Min. Alarm Set Point	Max. Alarm Set Point
Combustible (%LEL)	10	20	5	60
O ₂ (% vol)	19.5	23.0	5.0	24.0
H ₂ S (ppm)	5	10	5	175
CO (ppm)	25	100	10	1700

Sensor	Calibration Set point
Combustible (% LEL)	50
O ₂ (% vol)	15.0
H ₂ S (ppm)	20
CO (ppm)	60

Feature	Options
Detector password	App supports up to 6 digit numeric values
Calibration Due days	1 - 180, default is off
Periodic log collection rate	30 minutes
Frontlight timeout	30 seconds
Gas measurement Units	Combustible % LEL or % vol
	Toxic ppm
	O ₂ % vol

11.3.1 Calibration Gas Defaults

Recommended calibration gas, Part Number 10048890



Additional calibration gas options are included in this manual.

Gas	Default Cal	Units
CO	60	PPM
O ₂	15.0 %	VOL
H ₂ S	20	PPM
Combustible	50.0 %	LEL

11.4 Gas Performance Specification

11.4.1 Combustible Gas

Range	0 to 100 % LEL or 0 to 5 % vol
Resolution	1 % LEL or 0.05 % vol
Response Time	90 % of final reading in less than or equal to 10 sec (methane) (normal temperature range)
Reproducibility	3 % LEL, 0 % to 50 % LEL reading or 0.15% vol, 0.00% to 2.50% vol (normal temperature range)
	5 % LEL, 50 % to 100 % LEL reading or 0.25% vol, 2.50% to 5.00% vol (normal temperature range)
	5 % LEL, 0 % to 50 % LEL reading or 0.25% vol, 0.00% to 2.50% vol (extended temperature range)
	8 % LEL, 50 % to 100 % LEL reading or 0.4% vol, 2.50% to 5.00% vol (extended temperature range)

11.4.2 Oxygen



The oxygen sensor has built-in temperature compensation. However, if temperature shifts dramatically, the oxygen sensor reading may shift.

Range	0 to 30 vol. % O ₂ . Certified for 0-21 vol. % O ₂
Resolution	0.1 vol. % O ₂
Reproducibility (0 to 30 vol. % O ₂)	0.7 vol. % O ₂
Response time (90% of final reading)	< 15 seconds (normal temperature range)
Sensor Cross-Sensitivity	The oxygen sensor has no common cross-sensitives

11.4.3 Carbon Monoxide



Data is presented as the indicated output in PPM which will result from the application of the test gas.

Range	0 - 1999 ppm CO
Resolution	1 ppm CO for 0 to 1999 ppm
Reproducibility	±5 ppm CO or 10 % of reading, whichever is greater (normal temperature range)
	±10 ppm CO or 20 % of reading, whichever is greater (extended temperature range)
Response time (normal temperature range)	90% of final reading in less than or equal to 15 seconds
Sensor Cross-Sensitivity	See table below

US

11.4.4 Carbon Monoxide Cross Sensitivity

Test Gas Applied	Concentration (PPM) Applied	CO Channel % Cross-sensitivity
Hydrogen Sulfide (H ₂ S)	40	0
Carbon Monoxide (CO)	100	100
Nitric Oxide (NO)	50	84
Nitrogen Dioxide (NO ₂)	11	0
Chlorine (Cl ₂)	10	0
Hydrogen Cyanide (HCN)	30	-5
Ammonia (NH ₃)	25	0
Toluene	53	0
Isopropanol	100	-8
Hydrogen (H ₂)	100	48



Data is presented as the indicated output in PPM which will result from the application of the test gas.

11.4.5 Hydrogen Sulfide

Range	0-200 ppm H ₂ S
Resolution	1 ppm H ₂ S For 3 to 200 ppm H ₂ S
Reproducibility	±2 ppm H ₂ S or 10 % of reading, whichever is greater 0 to 100 ppm H ₂ S (normal temperature range) ±5 ppm H ₂ S or 10 % of reading, whichever is greater (extended temperature range)
Response time (normal temperature range)	90 % of final reading in less than or equal to 10 seconds

Test Gas Applied	Concentration (PPM) Applied	H ₂ S Channel % Cross-sensitivity
Hydrogen Sulfide (H ₂ S)	40	100
Carbon Monoxide (CO)	100	1
Nitric Oxide (NO)	50	25
Nitrogen Dioxide (NO ₂)	11	-1
Chlorine (Cl ₂)	10	-14
Hydrogen Cyanide (HCN)	30	-3
Ammonia (NH ₃)	25	-1
Toluene	53	0
Isopropanol	100	-3
Hydrogen (H ₂)	100	0

US

12 Patents

- US 8826721
- US 7959777
- US 8702935
- US 8790501
- Additional patents pending

13 Ordering Information

To order parts, go to msasafety.com

13.1 Detector Spare Parts and Accessories

Description	Part Number
SUNSHIELD KIT, io360	10205504
REPLACEMENT KIT, BATTERY, 3 PACK, io360	10201430
REPLACEMENT KIT, COMB -EVO SENSOR, io360	10203721
REPLACEMENT KIT, O ₂ SENSOR, io360	10203724
REPLACEMENT KIT, COMBUSTIBLE SENSOR, io360	10203709
REPLACEMENT KIT, CO/H ₂ S SENSOR, io360	10203710
REPLACEMENT KIT, HORN, io360	10201433
HOUSING, FRONT, RP, BLACK, io360	10201434
HOUSING, BACK, RP, BLACK, io360	10201435
HOUSING, FRONT, RP, GREEN, io360	10205505
HOUSING, BACK, RP, GREEN, io360	10205506
GASKET, SENSOR, REPLACEMENT, io360	10201436
REPLACEMENT KIT, SCREWS, io360	10201437
SENSOR SHIELD, REPLACEMENT, io360	10201438
CAP, CALIBRATION, REPLACEMENT, io360	10201439
D-RING, REPLACEMENT, io360	10203725
ALTAIR io360, SENSOR PLUG KIT	10205507

13.2 MSA HUB Spare Parts

Description	Part Number
MSA HUB Antenna 868 MHz	10202197-SP
MSA HUB Antenna 915 MHz	10202198-SP
MSA HUB Power Supply	10202199-SP
MSA HUB AC Cord, NA (type B)	10195720-SP
MSA HUB AC Cord, EU (type F)	10203573-SP
MSA HUB AC Cord, UK (type G)	10208253-SP
MSA HUB AC Cord, CH (type L)	10208430-SP
MSA HUB AC Cord, AR (type I)	10208431-SP
MSA HUB AC Cord, SA (type D)	10208432-SP
MSA HUB AC Cord, DK (type K)	10208433-SP
MSA HUB DC Cord, 25 m	10203365-SP
MSA HUB Ethernet Cable	10195741-SP
MSA HUB Mounting Flanges	10203364

US

WARNING!

Repair or alteration of the detector beyond the procedures described in this manual or by anyone other than a person authorized by MSA, could cause the unit to fail to perform properly. Use only genuine MSA replacement parts when performing any maintenance procedures described in this manual.

Substitution of components can seriously impair performance of the unit, alter intrinsic safety characteristics or void agency approvals.

Failure to follow this warning can result in serious personal injury or death.

WARNING!

Alterations of the HUB beyond the procedures described in the Setup, Deployment, Operation, and Decommissioning sections of this manual or by anyone other than a person authorized by MSA, could cause the unit to fail to perform properly.

Repair of the HUB must be performed by a person authorized by MSA.

Failure to follow this warning can result in serious personal injury or death.



Refer to EN 60079-29-2 (Guide for the selection, installation, use and maintenance of apparatus for the detection and measurement of combustible gases or oxygen) and EN 45544-4 (Guide for the selection, installation, use and maintenance of electrical apparatus used for the direct detection and direct concentration measurement of toxic gases and vapors).

13.3 Calibration

Description	Part Number
fixed flow regulator	467895
GAS, 34 L, METHANE 2.5 %, O ₂ -15%, CO-60 PPM, H ₂ S-20 PPM	10048981
GAS, 58 L, METHANE 2.5 %, O ₂ -15 %, CO-60 PPM, H ₂ S-20 PPM	10048890
GAS, 58 L, METHANE 2.5%, O ₂ -15%, H ₂ S-20 PPM	10048889
GAS, 34 L, CO-60 PPM, H ₂ S-20 PPM	10153800
GAS, 58 L, CO-60 PPM, H ₂ S-20 PPM	10153801
GAS, 34 L, H ₂ S-20 PPM	10153844
GAS, 58 L, H ₂ S-20 PPM	10153845
GAS, 27 L, METHANE 2.5 %	459942
GAS, 27 L, 60 PPM CO	461768
GAS, 34 L, CH ₄ 2.5 %, O ₂ -15%, CO-60, H ₂ S-20	10207602*
GAS, 58 L, CH ₄ 2.5%, O ₂ -15%, CO-60, H ₂ S-20	10207603*
GAS, 58 L, CH ₄ 2.5%, O ₂ -15%, H ₂ S-20	10207604*
Gas 34 L: 60 ppm CO, 20 ppm H ₂ S	10154976*
Gas 58 L: 60 ppm CO, 20 ppm H ₂ S	10154977*
Gas 34 L: 20 ppm H ₂ S	10155919*
Gas 58 L: 20 ppm H ₂ S	10155918*
Gas can [34 L] 2,5 Vol % Methane in air	10029471*
Gas can [34 L] 60 ppm CO in synth air	10073231*

*denotes cylinders are available in Europe only

US

